

## Features

- 3535 LED
- High efficacy up to 120lm/W
- High brightness and small voltage drop of single bar, radiation-free
- Lighting by both the positive and reverse wiring of power supply
- Stable and reliable performance, easy installation
- 4 specifications for options

## Application

- Subway, supermarket, bus stop, large shopping mall, etc.

## Installation

- Fix by screws
- Fix by clips

## Optical & Electrical Parameters

Model No.	Light Color	Color Temperature(K)	Beam Angle	Ra	Luminous Flux(lm/pcs)	Efficacy (lm/w)	Voltage (DC V)	Power (W/pcs)
BPS1-S3	W	>6400	7*30°	70+	864	120	24	7.2
BPS1-S5					1296			10.8
BPS1-S6					1584			13.2
BPS1-S8					1872			15.6

## Other Parameters

Model No.	LED Quantity (pcs)	Product Size L*W*H(mm)	Max Run (Single Feed)	Working Temperature	Storage Temperature
BPS1-S3	3	219*25*14.8	10 pcs	-20~+60°C	-20~+70°C
BPS1-S5	5	365*25*14.8	6 pcs		
BPS1-S6	6	438*25*14.8	5 pcs		
BPS1-S8	8	360*25*14.8	4 pcs		

### Note:

- Test environment temperature : 25±2°C.
- The above data is typical values. The actual data of each single product may differ from the typical values. The data is subject to change without notice.
- Luminous flux is tested when lighting on with the single color.
- Different color temperature will make luminous flux different.
- Power tolerance within ±10%.

## Profile Drawings

Unit:mm

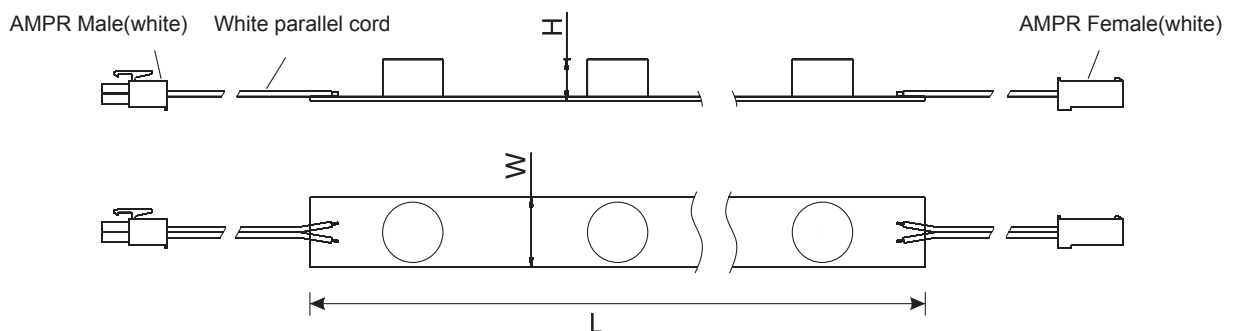

Note: Please ask the sales for detail drawing

### Luminous Intensity Distribution Diagram

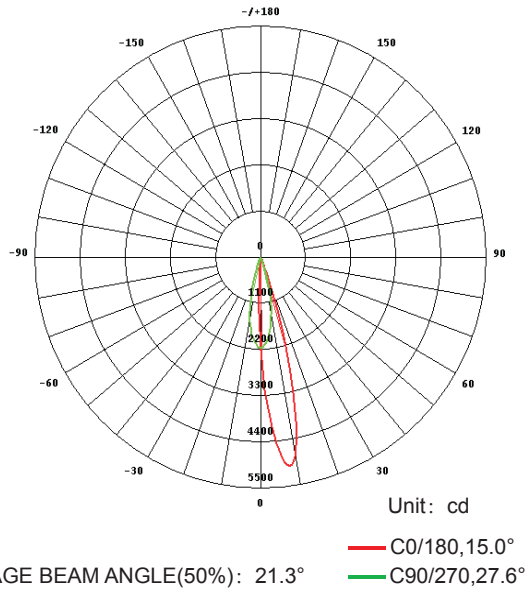

### Average Illumination

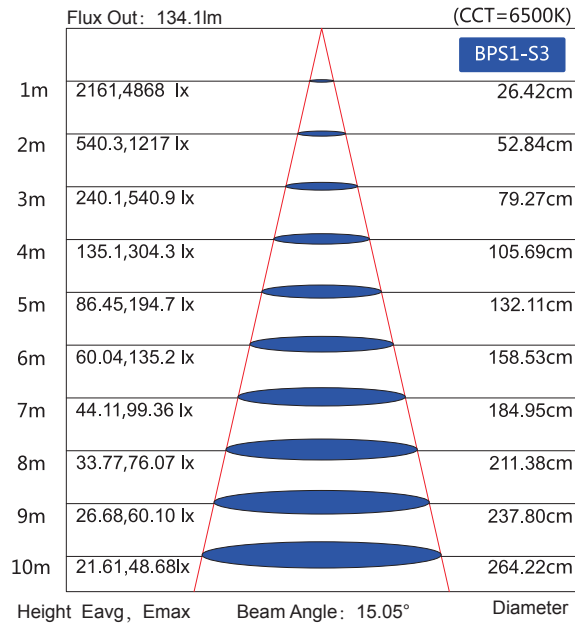

Note: The above two figures are tested with the sample BPS1-S3 at 6500K, please contact the sales for other spec. or CCT.

## Packaging

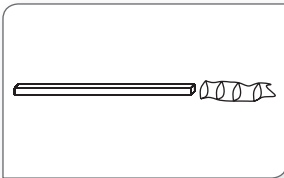

Put the product into PE bag.

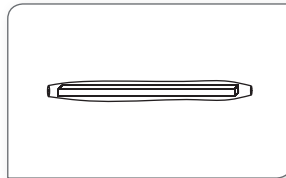

Seal the bag in two ends and label it.

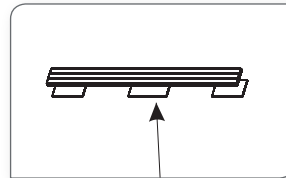

Separate the product layer by layer with foam.

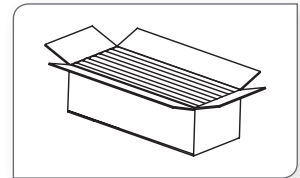

Put the product and accessories bag into carton box.

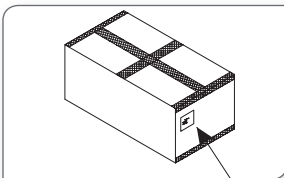

Seal and label the box.

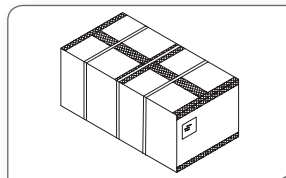

Use packing belt to pack. Add edge protectors if necessary.

### Packaging information

Model No.	Product Size L*W(mm)	Carton Size(mm)	Total Quantity (Pcs/Carton)	Net Weight(kg)	Gross Weight(kg)
BPS1-S3	219*25	390*390*325	132	7.25(1±10%)	8.55(1±10%)
BPS1-S5	365*25	390*390*325	132	8.05(1±10%)	9.55(1±10%)
BPS1-S6	438*25	550*400*340	144	10.35(1±10%)	11.85(1±10%)
BPS1-S8	360*25	390*390*325	132	8.05(1±10%)	9.55(1±10%)

#### Note:

- Shipping materials: PE bags and carton box.
- The above quantity and weight are only for the illustrated packaging method. There will be differences in the quantity and weight with other packaging methods.

## Installation

### 1.Connection Diagram

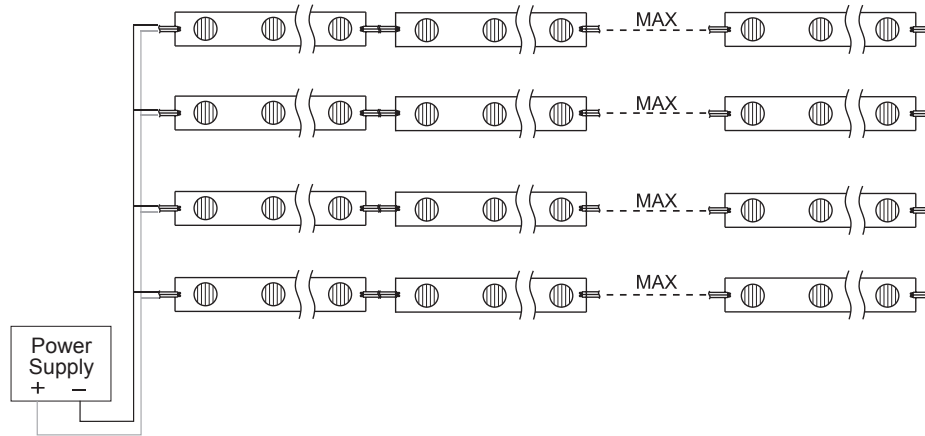

### 2.Installation Reference

Model No	Lightbox	Lighting Mode	Surface Material	Width (m)	Depth (cm)	Density (PCS/2m)	Illumination (Lux)	Evennes
BPS1-S5	Double-sided Lightbox	Double Side	White Soft Film	3	10	3*2	580-1330	0.44
				1.5	10	3*2	1670-2110	0.79
				2	12	3*2	1130-1520	0.74
				1	12	3*2	1870-2450	0.77
				2	15	3*2	870-1350	0.64
				1	15	3*2	1510-2110	0.72

**Note:**

The density is within a light box of 1 square meter. PCS/m indicates the product quantity installed on single side, and PCS/2m indicates the quantity of double-sided installation.

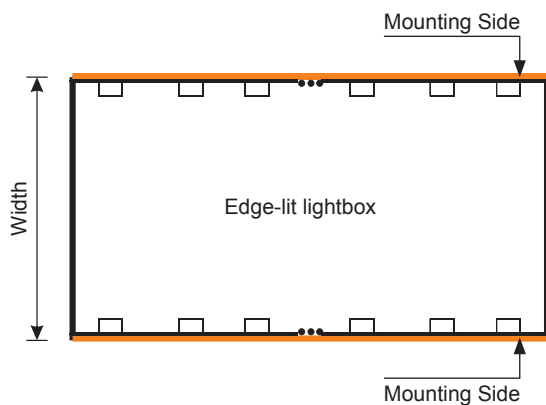

**Note:**

- The density refers to product quantities installed on the mounting side, and "3\*2" refers to 2 mounting sides and each side with 3pcs.
- The spacing means centre spacing of the product, see the left.
- The above products use porcelain whiteboard.

### 3. Accessories and Tools

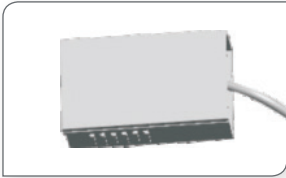

LED Power Supply



Diagonal Pliers



Mounting Gasket



M3 Self-tapping Screw



T-screw Kit



Terminals

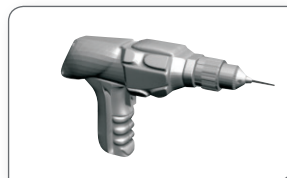

Electric Drill



Clips

### 4. Installation Steps

Method 1: fix by screw

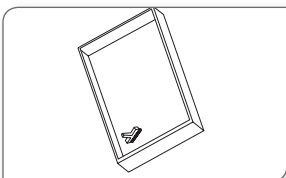

Clean the mounting surface.

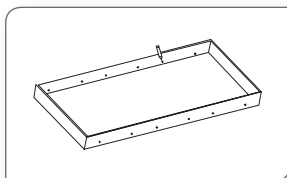

Determine the mounting position on the mounting edge.

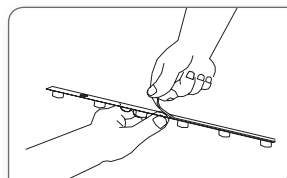

Peel away the release paper on the back of product and prefix the product to the mounting edge.

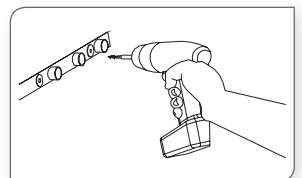

Fix the product with self-tapping screw  
 Make sure to add plastic gaskets to insulate the screw from the product during mounting.  
 Screw to avoid welding plate, avoiding short circuit

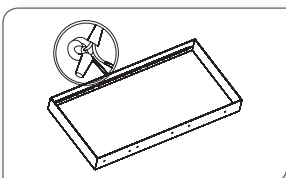

For bare wire connection, please use terminals.

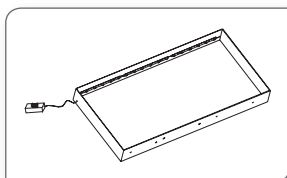

After fixing the product, power on for self-test.

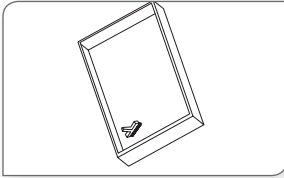
**Method 1: fix by T-screw Kit**

Clean the mounting surface.

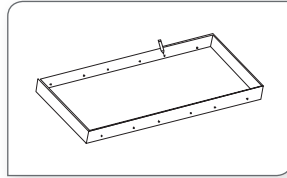

Determine the mounting position on the mounting edge.

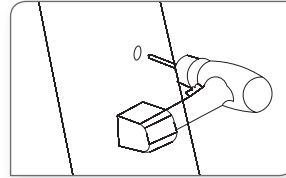

Drill the fixing holes with electric drill.

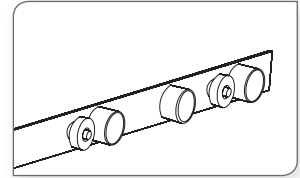

Mounting the product at inner side of lightbox and tighten the nut. Note that the connection end is a male-female docking.

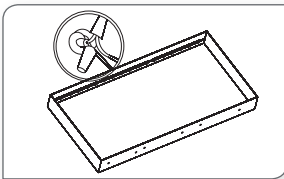

For bare wire connection, please use terminals.

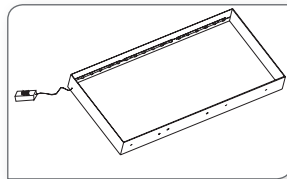

After fixing the product, power on for self-test.

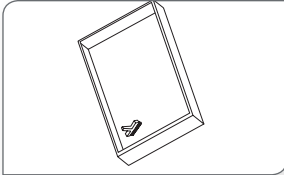
**Method 1: fix by clips**

Clean the mounting surface.

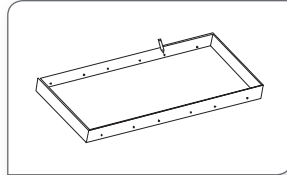

Determine the mounting position on the mounting edge.

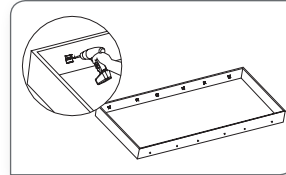

Drill the fixing holes with electric drill.

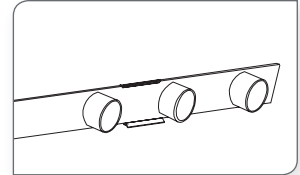

Fix the product with clips.

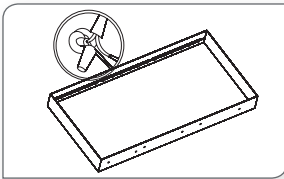

For bare wire connection, please use terminals.

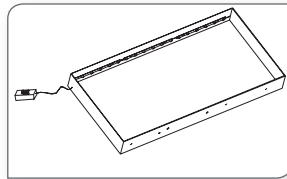

After fixing the product, power on for self-test.

## Attentions

- Before installation, check that the product parameters are consistent with the requirements (Seeing product specifications or product labels)
- Load voltage, current, power and power supply should be matched with the product.
- Follow the instructions of wiring diagram (first connect the product and then the power supply) to avoid short circuit.
- Make sure the correct connection of positive and negative poles between the product and power supply. Otherwise, the light will not be on.
- Make sure the power cord firmly screwed into the terminal and it should not be pulled out by hands.
- The terminal should have insulation, waterproof and anti-corrosive treatment

## Common Faults and Troubleshoot

Quick Guide		
Problems	Reasons	Solutions
All LEDs can not light on.	No electric supply.	Fix the short circuit problem.
	Automatic power protection from the open or short circuit in output of the power supply.	Fix the short circuit problem.
	Wrong connection of power supply.	
LEDs can not light on partly.	Some switching mode power supplies are not powered.	Check the power supply system to fix it.
	Power supply line error.	
	Mistaken wire connection of some of products	Correctly connection
Brightness of LED is inconsistent or insufficient.	Power overloaded.	Replace with more powerful power
	Power supply circuit excessive consumption.	Make sure the working voltage of the product within $\pm 5\%$ of standard voltage, or keep balance by circuit power consumption.
	Excessive quantities in series connection of the product	Reduce the quantities of the product in series connection to meet requirement.
LED flicker.	Connection point fault.	Remove bad connection point.
	Switching power supply failure.	Replace a new power supply.
	Wrong Installation or use of products	Please follow the instructions



## Warning

- Do not disassemble or retrofit the light. Do not touch the surface of the light with a sharp object.
- Do not do live-line working during installation, especially for high voltage product.
- Do not use any organic chemical solvents.
- Use neutral glass adhesive to fix this product and it needs to be dried 4 hours in the open environment after operation.
- Treat the ends and the circuit connection points that are not connected to the main line with insulation, waterproof, and anti-corrosion in the installation.
- Use 18AWG (0.75mm<sup>2</sup> cross-sectional area) or thicker core wire to avoid adverse consequences caused by overheating, if the power cable need to lengthen.
- Make sure the input voltage meets the requirements and lines are connected correctly before lighting on.
- This product is for signage, and do not use as general lighting.
- The length of the power cable between the power supply and the Product should not exceed 2 meters. Otherwise, large circuit loss will lead to inconsistent brightness.
- Installation, maintenance and repair should be operated by a qualified technician.
- Make sure the series connection within max run.

## Statements and Recycling

### Statements:

- Repair should be operated by a qualified technician, if the external circuit or main line of this product is damaged.
- The parameters given in this manual are typical values and for reference only.
- All illustrations and drawings in this manual are for reference.
- This product is subject to change without notice.

### Recycling:

- LED lighting products belongs to electronic products, please do recycling treatment according to the relevant WEEE directives.