

Features

- Applied for light panel with light guidance
- FR4 slim 4mm PCB
- Excellent Light Uniformity
- 2835 LED, 3leds cuttable
- Long life span

Application

LED light guide plate

BLUEVIEW ELEC-OPTIC TECH CO.,LTD













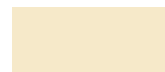
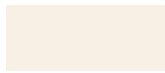

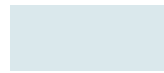
Tel: +86-28-8148 0011 Fax: +86-28-8148 1258
Mail: sales@blueviewled.com Web.: www.blueviewled.com
Add: No.1000, Section 2, 2nd Konggang Road, Southwest
Aviation Industrial Development Zone, Chengdu,Sichuan, China.
Zip code: 610207

Specifications are subject to change without notice.
© Blueview™ 2016 – All rights reserved. Made in China.

Specifications

Code name	BV-BAR-2835-90
Color	white
CCT(K)	2500-25000k
View Angle(°)	120°
Luminous Flux(lm)	687
RA	>80>90>95
Light Efficiency(lm/w)	105(Ra80)
Voltage	12VDC
Power(w)	6.5
Standard Serial connection Qty (pcs)	2
Operating Temperature(°C)	-25~+60
Storage Temperature(°C)	-25~+70
Protection Class	IP60

Color Available

			
2500K	2700K	3000K	3500K
			
4200K	5000K	6500K	9000K
			
10000K	11000K	12000K	25000K
			
Yellow	Red	Green	Blue

BLUEVIEW ELEC-OPTIC TECH CO.,LTD

Tel: +86-28-8148 0011 Fax: +86-28-8148 1258
 Mail: sales@blueviewled.com Web.: www.blueviewled.com
 Add: No.1000, Section 2, 2nd Konggang Road, Southwest
 Aviation Industrial Development Zone, Chengdu,Sichuan, China.
 Zip code: 610207

Specifications are subject to change without notice.
 ©Blueview™ 2016 – All rights reserved. Made in China.

Luminous Intensity Distribution Diagram

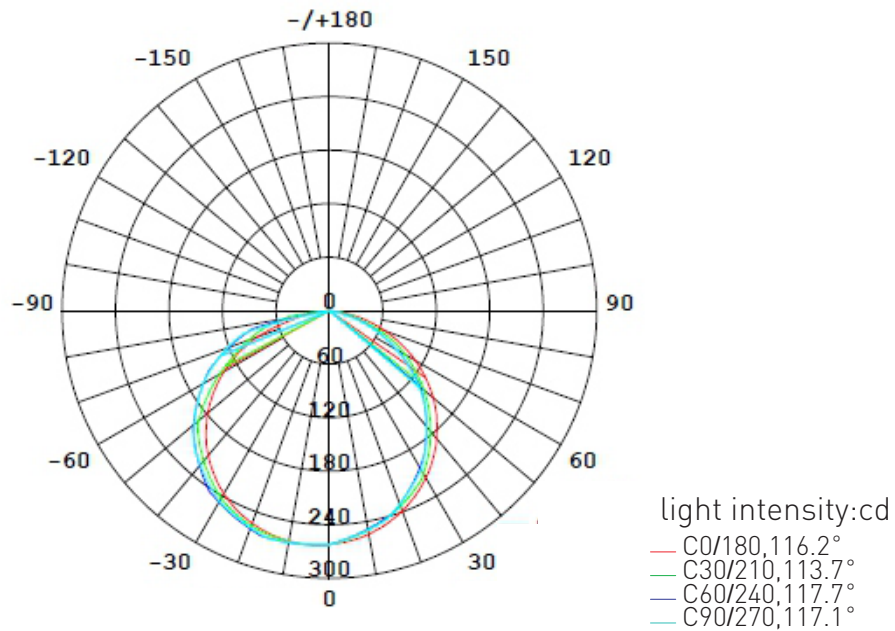

THE AVERAGE BEAM ANGLE(50%):116.2 DEG

Structure Chart

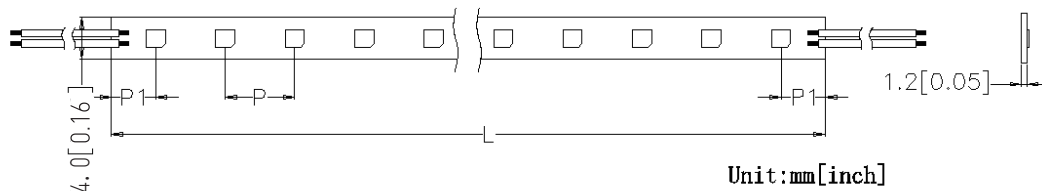

Lenght "L"	Pitch "P"	Pitch "P1"	LED S/PC
1000[39.37]	11.1[0.44]	5.6[0.22]	90

BLUEVIEW ELEC-OPTIC TECH CO.,LTD

Tel: +86-28-8148 0011 Fax: +86-28-8148 1258
 Mail: sales@blueviewled.com Web.: www.blueviewled.com
 Add: No.1000, Section 2, 2nd Konggang Road, Southwest
 Aviation Industrial Development Zone, Chengdu,Sichuan, China.
 Zip code: 610207

Specifications are subject to change without notice.
 ©Blueview™ 2016 – All rights reserved. Made in China.

Installation //

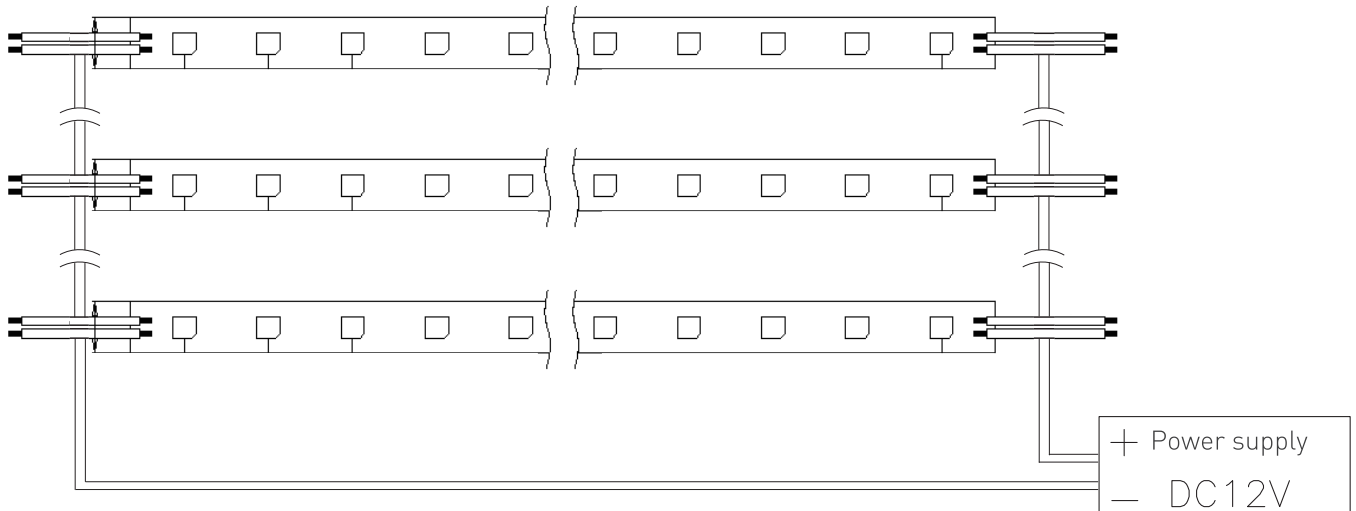

BLUEVIEW ELEC-OPTIC TECH CO.,LTD

Tel: +86-28-8148 0011 Fax: +86-28-8148 1258
Mail: sales@blueviewled.com Web.: www.blueviewled.com
Add: No.1000, Section 2, 2nd Konggang Road, Southwest
Aviation Industrial Development Zone, Chengdu,Sichuan, China.
Zip code: 610207

Specifications are subject to change without notice.
©Blueview™ 2016 – All rights reserved. Made in China.

Package

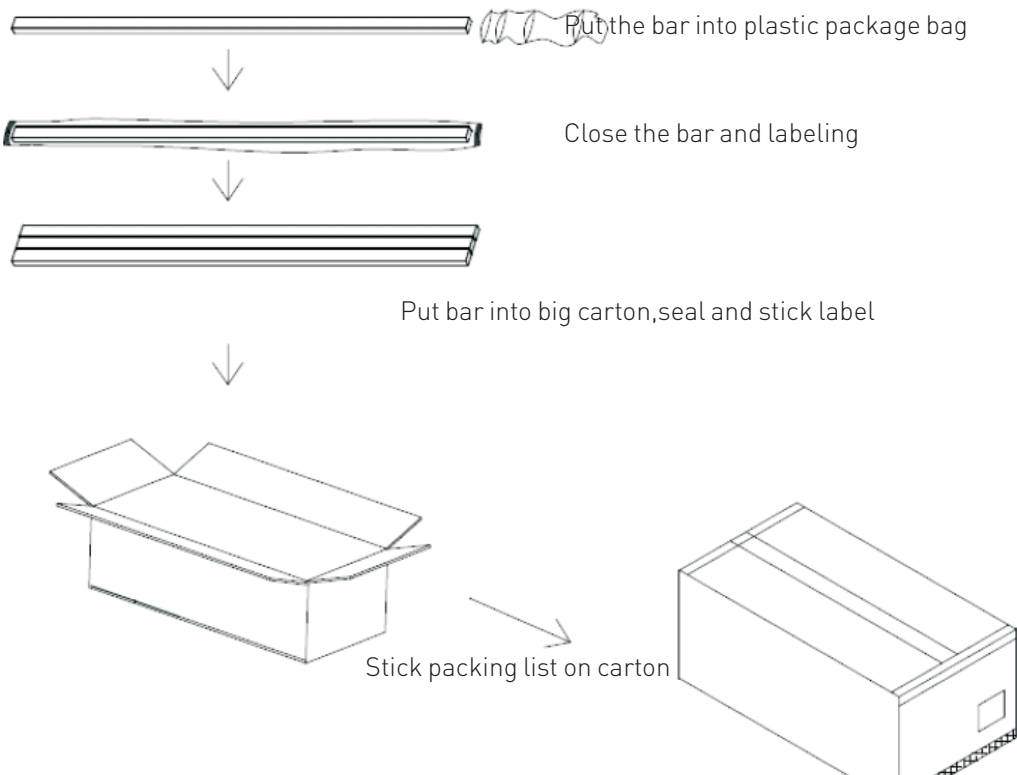

Product size	Led Qty	Carton size (mm)	Qty per carton	Net weight (NW/kg)	Gross weight (GW/kg)
1000mm	90	1100*400*380	240	17.6(1±10%)KG	19.0(1±10%)KG

Notice:

- 1, Carton size: outer packaged with five layers of cardboard, the five model takes cartons with different sizes, please see as follows.
- 2, Above quantity and weight are subject to the package as diagram shows, please take the practical product as standard, when package changed.

BLUEVIEW ELEC-OPTIC TECH CO.,LTD

Tel: +86-28-8148 0011 Fax: +86-28-8148 1258
 Mail: sales@blueviewled.com Web.: www.blueviewled.com
 Add: No.1000, Section 2, 2nd Konggang Road, Southwest Aviation Industrial Development Zone, Chengdu, Sichuan, China.
 Zip code: 610207

Specifications are subject to change without notice.
 ©Blueview™ 2016 – All rights reserved. Made in China.