

Features

- 1.High efficiency 147lm/W and CRI 95+.
- 2.High brightness&low temperature rise
- 3.Excellent weather resistance and UV resistance
- 4.Flexible and cuttable,easy installing
- 5.Multiple spec. optional,customizable.

Bending radius: Rmin=30mm



Application

Applied for display prop lighting,like display case and display rack etc.

Installation

Fix by 3M self adhesive tape



Optical & Electrical Parameters

90+

Model No.	Light Color	Color Temperature/ Wavelength(K/nm)	Beam Angle	Typical Luminous Flux(lm/m)	Ra	Efficacy	Voltage (DC V)	Power (W/m)
F2-T-H2835-64-24	W	2600-2800	120°	768	90+	133	24V	6
		2800-3200		771		134		
		3800-4300		781		136		
		4700-5300		815		141		
		5800-6800		829		143		
F2-T-H2835-96-24	W	2600-2800	120°	781	90+	136	24V	6
		2800-3200		785		136		
		3800-4300		793		137		
		4700-5300		806		139		
		5800-6800		811		141		
F2-T-H2835-128-12/24	W	2600-2800	120°	1049	90+	136	12/24V	8
		2800-3200		1052		137		
		3800-4300		1089		141		
		4700-5300		1124		146		
		5800-6800		1127		147		

95+

Model No.	Light Color	Color Temperature/ Wavelength(K/nm)	Beam Angle	Typical Luminous Flux(lm/m)	Ra	Efficacy	Voltage (DC V)	Power (W/m)
F2-T-H2835-64-24	W	2600-2800	120°	582	95+	101	24V	6
		2800-3200		589		102		
		3800-4300		646		112		
		4700-5300		652		113		
		5800-6800		659		114		
F2-T-H2835-96-24	W	2600-2800	120°	585	95+	101	24V	6
		2800-3200		601		104		
		3800-4300		671		116		
		4700-5300		689		119		
		5800-6800		701		121		
F2-T-H2835-128-12/24	W	2600-2800	120°	781	95+	102	12/24V	8
		2800-3200		793		103		
		3800-4300		889		116		
		4700-5300		893		116		
		5800-6800		915		119		



Temperature-Related Parameters(Normal Working)

Model No.	Power(W/m)	No Brightness Difference MAX(m)	UL Max Run (m)	T _A (°C)	Operating Temp MAXTc(°C)
F2-T-H2835-64-24	6	8	13	-20~+60°C	--
F2-T-H2835-96-24	6	8	13		
F2-T-H2835-128-12	8	6	10		
F2-T-H2835-128-24	8	5	8		

Other Parameters

Model No.	LED Quantity(pcs/m)	Min Cuttable Length(mm)	Storage Temperature(°C)
F2-T-H2835-64-24	64	124.5	-20~+70°C
F2-T-H2835-96-24	96	83.3	
F2-T-H2835-128-12	128	31.3	
F2-T-H2835-128-24	128	62.5	

NOTE:

- 1.Test environment temperature : 25±2°C.
2. Figures above are typical figures. Actual figures could be different with typical figures, and the data is subject to change without notice.
- 3.The luminous flux is tested with corresponding color light on.
- 4.Different color temperature or wavelength will make luminous flux different.
5. The Luminous efficiency is measured value.
- 6.Max run is in single feed.
- 7.The luminous flux and power tolerance within ±10%.
- 8.Cutting marks see profile drawing below.

Profile Drawings

Unit:mm[inch]

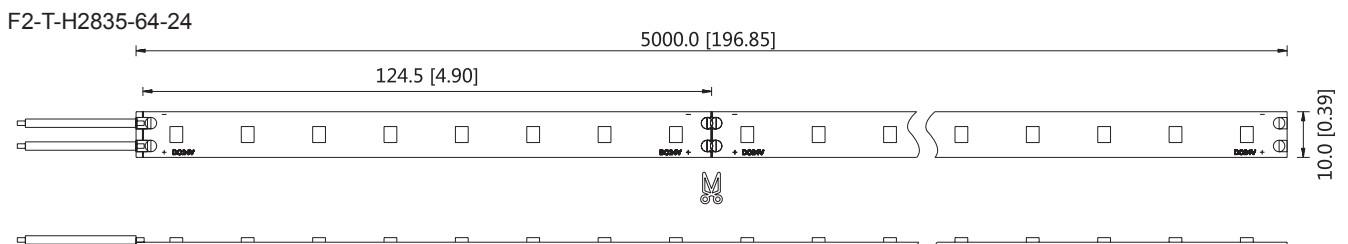



F2-T-H2835-96-24

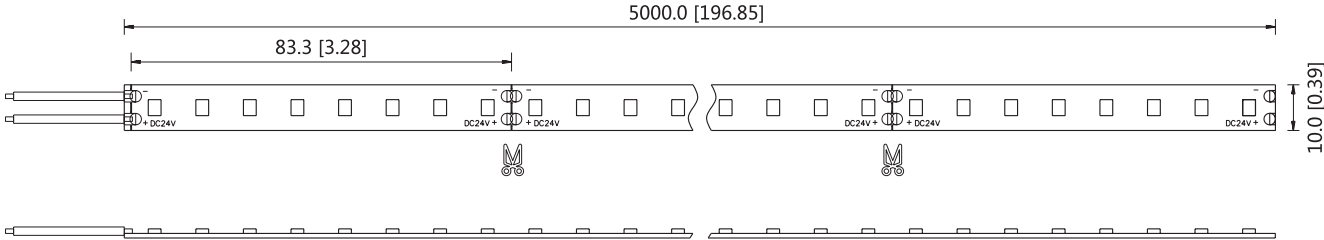

F2-T-H2835-128-12

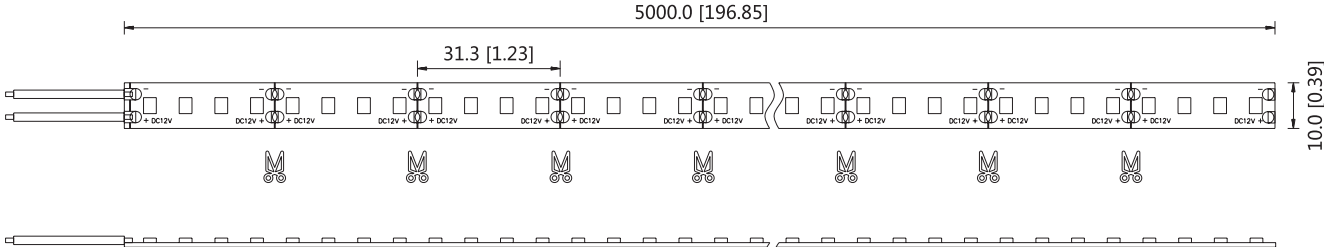

F2-T-H2835-128-24

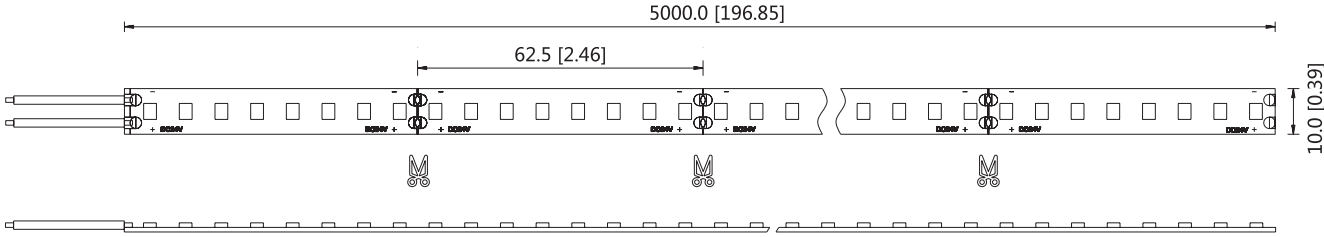

Note:For detail drawing,please consult sales rep.



packing

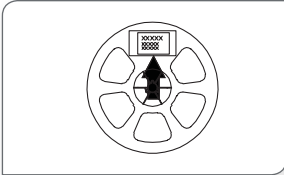

Label the reel;

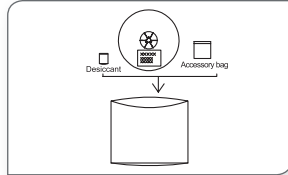

Put reel, accessory bag and desiccant together into static shielding bag;

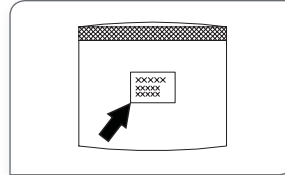

Seal and label the static shielding bag;

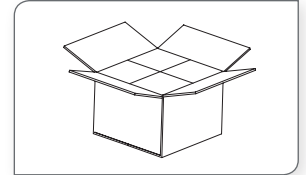

Put the packed static shielding bag into carton box;

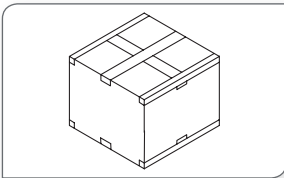

Seal the carton box;

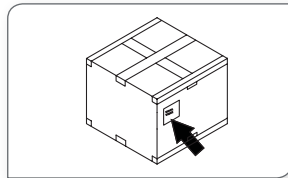

Label the box;

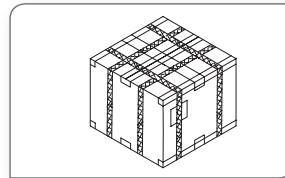

Use packing belt to pack. Add edge protectors if necessary.

Packaging information

Model No.	Product Size L*W(mm)	Carton Size(mm)	Meter/Reel	Reel/Carton	Net Weight(kg)	Gross Weight(kg)
F2-T-H2835-64-24	5000*10	550*400*340	5	100	7.93(1±10%)	12.50(1±10%)
F2-T-H2835-96-24					8.06(1±10%)	12.69(1±10%)
F2-T-H2835-128-12/24					8.36(1±10%)	12.99(1±10%)

Note:

Each reel packing in a static shielding bag.

The above quantity and weight are only for the illustrated packaging method. There will be differences in the quantity and weight with other packaging methods.

Installation

1.Products and Tools



F2-T-H2835-XXX-XX

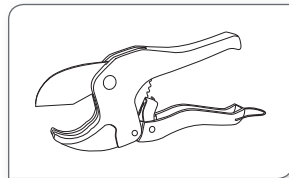

Cutting tool

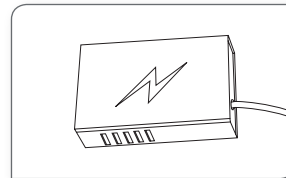

LED Power Supply

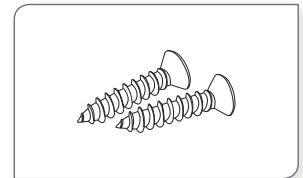

Self-tapping screw

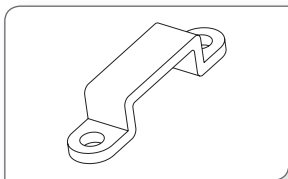

Mounting clips

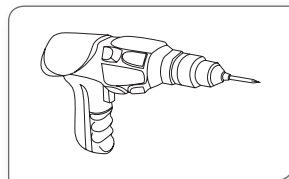

Electric drill

2. Installation Methods and Steps

Aluminum channel installation

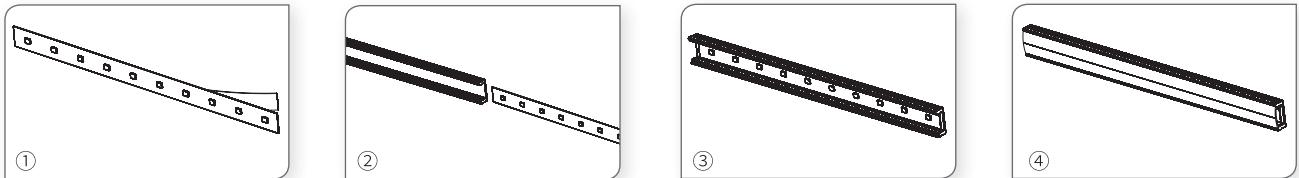

1. Peel away the self adhesive tape on the back of strip.
2. Cut off the excess part based on the installation position.
3. Evenly arrange the strips with appropriate space in the track.
4. Install the cover and end cap.

Covered channel installation

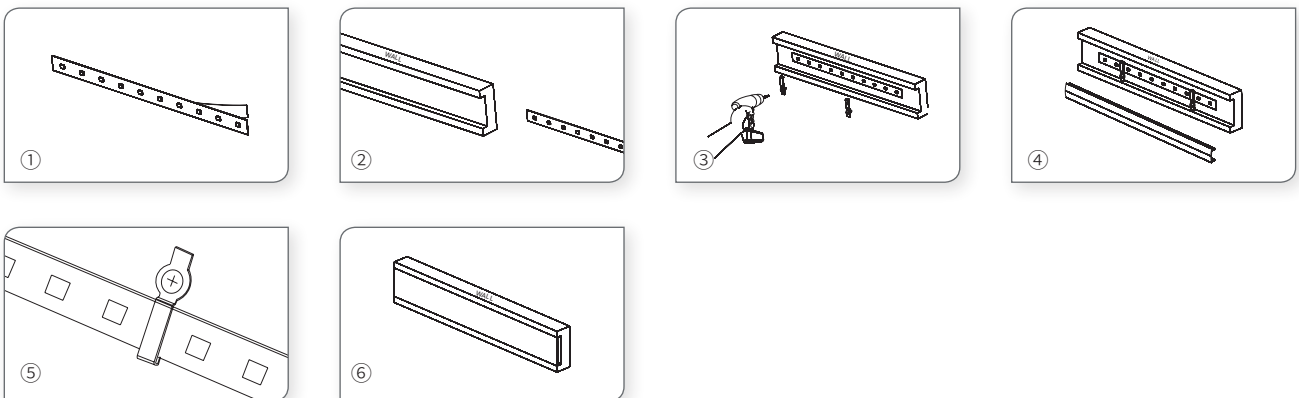

1. Peel away the self adhesive tape on the back of strip.
2. Cut off the excess part based on the installation position.
3. Evenly arrange the strips with appropriate space in the track and fix them with clips.
4. Install the cover and end cap.
5. Clip installation as the figure show
6. Finished



Attentions before installation

- Before installation, check that the product parameters are consistent with the requirements (Seeing product specifications or product labels)
- Load voltage, current, power and power supply should be matched with the product.
- Follow the instructions of wiring diagram (first connect the load and then the power supply) to avoid short circuit.
- Make sure the correct connection of positive and negative poles between products and power supply. Otherwise, the light will not be on.
- Make sure the power cord firmly screwed into the terminal and it should not be pulled out by hands.
- The terminal should have insulation, waterproof and anti-corrosive treatment.
- If the working length exceeded the max run length, make sure to have extra power supply.
- If it needs higher current of a LED, make sure having extra cooling.

Common Faults and Troubleshoot

Quick Guide		
Problems	Reasons	Solutions
All LEDs can not light on.	No electric supply.	Power on
	Automatic power protection from the open or short circuit in output of the power supply.	Fix the short circuit problem.
	Wrong connection of power supply.	
LEDs can not light on partly.	Some switching mode power supplies are not powered.	Check the power supply system to fix it.
	Power supply line error.	
	Mistaken wire connection of some of products	Correctly connection
Brightness of LED is inconsistent tor insufficient.	Power overloaded.	Replace with more powerful power
	Power supply circuit excessive consumption.	Make sure the working voltage of the product within $\pm 5\%$ of standard voltage, or keep balance by circuit power consumption.
	Excessive quantities in series connection of the product	Reduce the quantities of the product in series connection to meet requirement.
LED flicker.	Connection point fault.	Remove bad connection point.
	Switching power supply failure.	Replace a new power supply.
	Wrong Installation or use of products	Please follow the instructions

⚠ Warning

- Do not disassemble or retrofit the light. Do not touch the surface of the light with a sharp object.
- Do not do live-line working during installation, especially for high voltage product.
- Do not use any organic chemical solvents.
- Use neutral glass adhesive to fix this product and it needs to be dried 4 hours in the open environment after operation.
- Treat the ends and the circuit connection points that are not connected to the main line with insulation, waterproof, and anti-corrosion in the installation.
- Use 18AWG (0.75mm² cross-sectional area) or thicker core wire to avoid adverse consequences caused by overheating, if the power cable need to lengthen.
- Make sure the input voltage meets the requirements and lines are connected correctly before lighting on.
- This product is for signage, and do not use as general lighting.
- Series connection within the max run.
- The length of the power cable between the power supply and the led strip should not exceed 2 meters. Otherwise, large circuit loss will lead to inconsistent brightness.
- Installation, maintenance and repair should be operated by a qualified technician.

Statements and Recycling

Statements:

Repair should be operated by a qualified technician, if the external circuit or main line of this product is damaged.
The parameters given in this manual are typical values and for reference only.
All illustrations and drawings in this manual are for reference.
This product is subject to change without notice.

Recycling:

LED lighting products belongs to electronic products, please do recycling treatment according to the relevant WEEE directives.