



Lifetime



Certified



Certified



Certified



Warranty

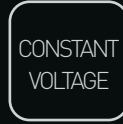

### Ra Available

### IP Grade Available



## Features

- Outdoor (IP65&IP67&IP68) & indoor (IP22) are available
- Epistar chips, LM80 tested
- Ra95+/Ra90+ /80+, with high R9 & R13 value
- Cuttable every 6 LEDs for 12V/ 24V
- 3M double sided tape for easy installation
- cULus Listed, 5 years warranty











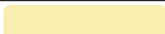

### BLUEVIEW ELEC-OPTIC TECH CO.,LTD

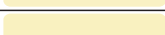
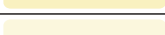
Tel: +86-28-8148 0011      Fax: +86-28-8148 1258  
 Mail: sales@blueviewled.com      Web.: www.blueviewled.com  
 Add: No.1000, Section 2, 2nd Konggang Road, Southwest  
 Aviation Industrial Development Zone, Chengdu,Sichuan, China.  
 Zip code: 610207

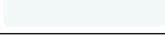
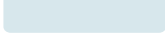
Specifications are subject to change without notice.  
 ©Blueview™ 2016 – All rights reserved. Made in China.

### Specifications

<b>LED Type</b>	SMD 3528	<b>Dimmable</b>	Yes (compatible with BV311 RF dimmer & BV Dimmer)
<b>LED Q'ty/m</b>	240pcs	<b>IP grade</b>	IP22 (IP65 & IP67&IP68 available upon request)
<b>Input Voltage</b>	12V / 24VDC Constant Voltage	<b>Installation</b>	3M™ double sided tape
<b>Power</b>	19.2W	<b>Working Temperature</b>	-25~+60 °C
<b>Cutting length</b>	12V 25mm 6 LEDs 24V 25mm 6 LEDs	<b>Max run</b>	12V 2.5 meters 24V 5 meters
<b>Strip Width</b>	14mm	<b>Certification</b>	E354137 cULus Listed, CE, RoHs
<b>Viewing Angle</b>	120°	<b>Warranty</b>	5 years/ 3 years <sup>Ⓞ</sup>

Order Code	CCT/ Color	CRI	Lumen/M <sup>Ⓝ</sup>
FN-3528A-240-12-25K	 2425-2580K	80+, 90+, 95+	1248
FN-3528A-240-12-27K	 2645-2800K	80+, 90+, 95+	1248
FN-3528A-240-12-30K	 2850-3025K	80+, 90+, 95+	1344
FN-3528A-240-12-35K	 3270-3545K	80+, 90+, 95+	1344
FN-3528A-240-12-42K	 3840-4060K	80+, 90+, 95+	1536
FN-3528A-240-12-50K	 4830-5095K	80+, 90+, 95+	1536
FN-3528A-240-12-55K	 5400-5800K	80+, 90+, 95+	1152
FN-3528A-240-12-65K	 6260-6680K	80+, 90+, 95+	1440
FN-3528A-240-12-90K	 7836-9000K	80+	1248
FN-3528A-240-12-R	 625nm	-	624
FN-3528A-240-12-G	 525nm	-	1020
FN-3528A-240-12-B	 465nm	-	396
FN-3528A-240-12-Y	 592nm	-	480
FN-3528A-240-12-PK	 Pink	-	840
FN-3528A-240-12-PL	 Purple	-	72

Note<sup>Ⓞ</sup>: Contact Blueview for exact warranty period and policy

Note<sup>Ⓞ</sup>: Lumen output are based on CRI80+ measured according to PMS-80, with a tolerance of +/- 5%

Note<sup>Ⓞ</sup>: Standard package: 5m/roll

#### BLUEVIEW ELEC-OPTIC TECH CO.,LTD

Tel: +86-28-8148 0011      Fax: +86-28-8148 1258  
 Mail: sales@blueviewled.com      Web.: www.blueviewled.com  
 Add: No.1000, Section 2, 2nd Konggang Road, Southwest  
 Aviation Industrial Development Zone, Chengdu, Sichuan, China.  
 Zip code: 610207

Specifications are subject to change without notice.  
 ©Blueview™ 2016 – All rights reserved. Made in China.

### Order Code

Model	Quality level	LED Q'ty/M	Input voltage	CCT/Color
<b>FN</b>	<b>3528A</b>	<b>240</b>	<b>12</b>	<b>27K</b>
FN-IP22	3528A-5 yrs warranty		12-12V DC	view table above for options
FWS-IP65	3528B-3 yrs warranty		24-24V DC	
FWT-IP67				
FWE-IP68				

### Dimension

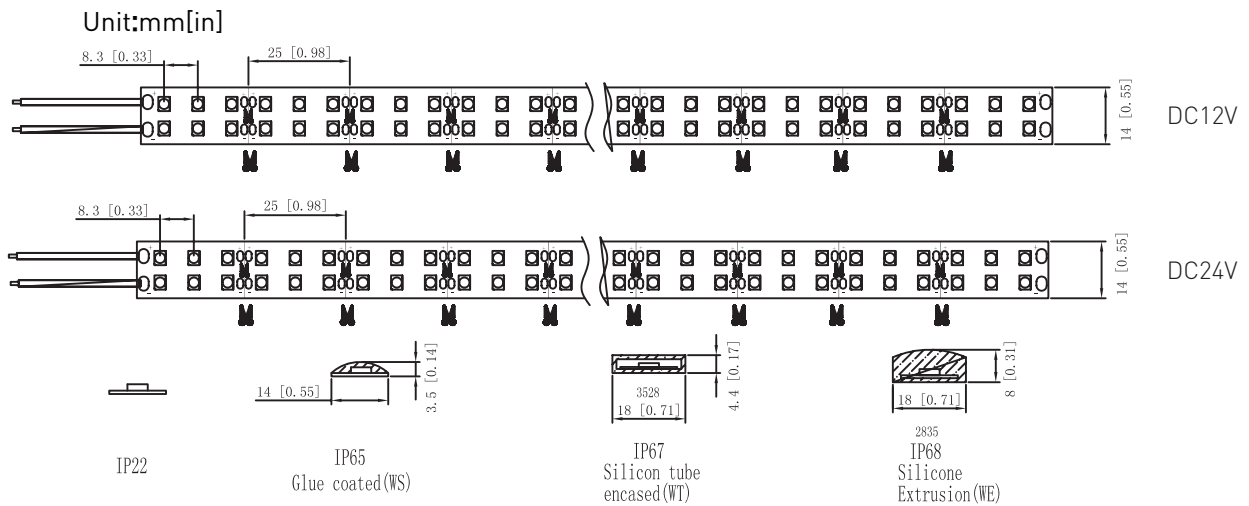

### Package

Roll strip on a reel, then put together  
With desiccant into aluminum foil bag

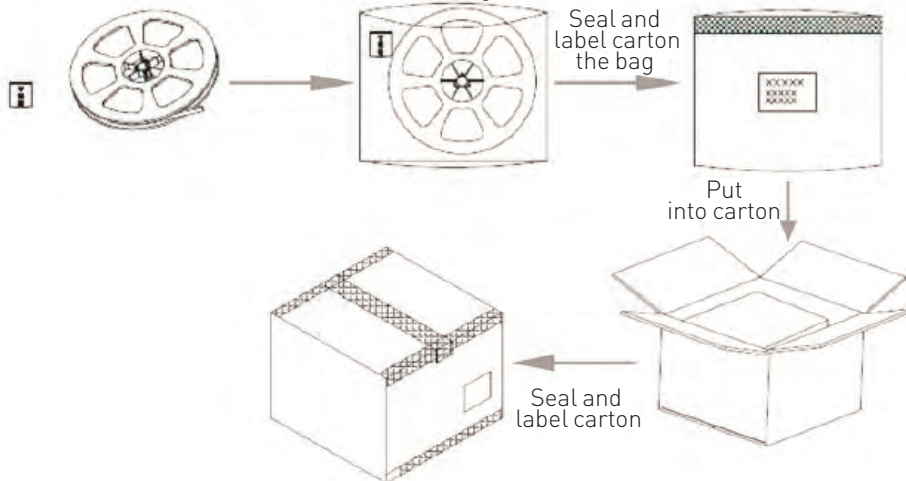

### Packing Info

Order Code	Net Weight / CTN	Gross Weight / CTN	Units / CTN	Carton Size
FN-3528A-240	8.12 (1±10%) kgs	12.02 (1±10%) kgs	70 rolls	550*400*340mm

Remark: Data to change according to reality without prior notice.

### BLUEVIEW ELEC-OPTIC TECH CO.,LTD

Tel: +86-28-8148 0011      Fax: +86-28-8148 1258  
 Mail: sales@blueviewled.com      Web.: www.blueviewled.com  
 Add: No.1000, Section 2, 2nd Konggang Road, Southwest  
 Aviation Industrial Development Zone, Chengdu,Sichuan, China.  
 Zip code: 610207

Specifications are subject to change without notice.  
 ©Blueview™ 2016 – All rights reserved. Made in China.