



One BIN only
for a CCT range



Lifetime



Certified



Certified



Certified



Warranty



Ra Available

IP Grade Available



Features

- Super bright 5050LEDs
- Epistar chips, LM-80 tested
- Ra90+ /80+, with high R9 & R13 value
- Wide color temperature range, one bin only for one CCT
- Silicone extrusion (IP68), tube encased (IP67), silicone coated (IP65) & indoor (IP22) are available
- Cuttable every 3 LEDs for 12V, 6 LEDs for 24V
- 3M double sided tape for easy installation
- cULus Listed, 5 years warranty









BLUEVIEW ELEC-OPTIC TECH CO.,LTD

Tel: +86-28-8148 0011 Fax: +86-28-8148 1258
 Mail: sales@blueviewled.com Web.: www.blueviewled.com
 Add: No.1000, Section 2, 2nd Konggang Road, Southwest
 Aviation Industrial Development Zone, Chengdu,Sichuan, China.
 Zip code: 610207

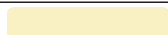
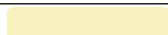
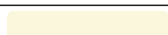
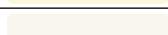
Specifications are subject to change without notice.
 ©Blueview™ 2016 – All rights reserved. Made in China.

Specifications

LED Type	SMD 5050	Dimmable	Yes (compatible with BV311 RF dimmer & BV Dimmer)
LED Q'ty/m	30pcs	IP grade	IP22 (IP65/IP68 available upon request)
Input Voltage	12V / 24V DC Constant Voltage	Installation	3M double sided tape(mounting clips for IP68)
Power	7.2W	Working Temperature	-25~+60 °C
Cutting length	12V: 100mm 3LEDs 24V: 200mm 6LEDs	Max run	12V: 3.5 meters (one end) 24V: 5 meters (one end)
Strip Width	10mm	Certification	E354137 cULus Listed, CE, RoHs
Viewing Angle	120°	Warranty	5 years/3years ^①

Order Code	CCT/ Color	CRI	Lumen/M ^②
FN-5050A-30-12-25K	 2425-2580K	80+	630±10%
FN-5050A-30-12-27K	 2725-2870K	80+/90+	660±10%
FN-5050A-30-12-31K	 3045-3220K	80+	690±10%
FN-5050A-30-12-35K	 3220-3465K	80+	660±10%
FN-5050A-30-12-42K	 3985-4260K	80+/90+	690±10%
FN-5050A-30-12-50K	 5028-5310K	80+/90+	600±10%
FN-5050A-30-12-58K	 5665-6020K	80+	660±10%
FN-5050A-30-12-65K	 6260-6530K	80+	594±10%
FN-5050A-30-12-90K	 8200-9000K	75+	720±10%
FN-5050A-30-12-R	 Red 620-625nm	-	-
FN-5050A-30-12-G	 Green 525-527.5nm	-	-
FN-5050A-30-12-B	 Blue 465-467.5nm	-	-
FN-5050A-30-12-Y	 Yellow 588-590nm	-	-

Note^①: Contact Blueview for exact warranty period and policy

Note^②: Lumen output are measured according to PMS-80, with a tolerance of +/- 5%

Note^③: Standard package: 5M/Roll

Order Code

Model	Quality level	LED Q'ty/M	Input voltage	CCT/Color
FN	5050	30	12V	25K
FN-IP22 FWS-IP65 FWT-IP67 FWE-IP68	5050A-5 yrs warranty 5050B-3 yrs warranty		12-12V DC 24-24V DC	View table above for optional

BLUEVIEW ELEC-OPTIC TECH CO.,LTD

Tel: +86-28-8148 0011 Fax: +86-28-8148 1258
 Mail: sales@blueviewled.com Web.: www.blueviewled.com
 Add: No.1000, Section 2, 2nd Konggang Road, Southwest
 Aviation Industrial Development Zone, Chengdu,Sichuan, China.
 Zip code: 610207

Specifications are subject to change without notice.
 ©Blueview™ 2016 – All rights reserved. Made in China.

Dimension

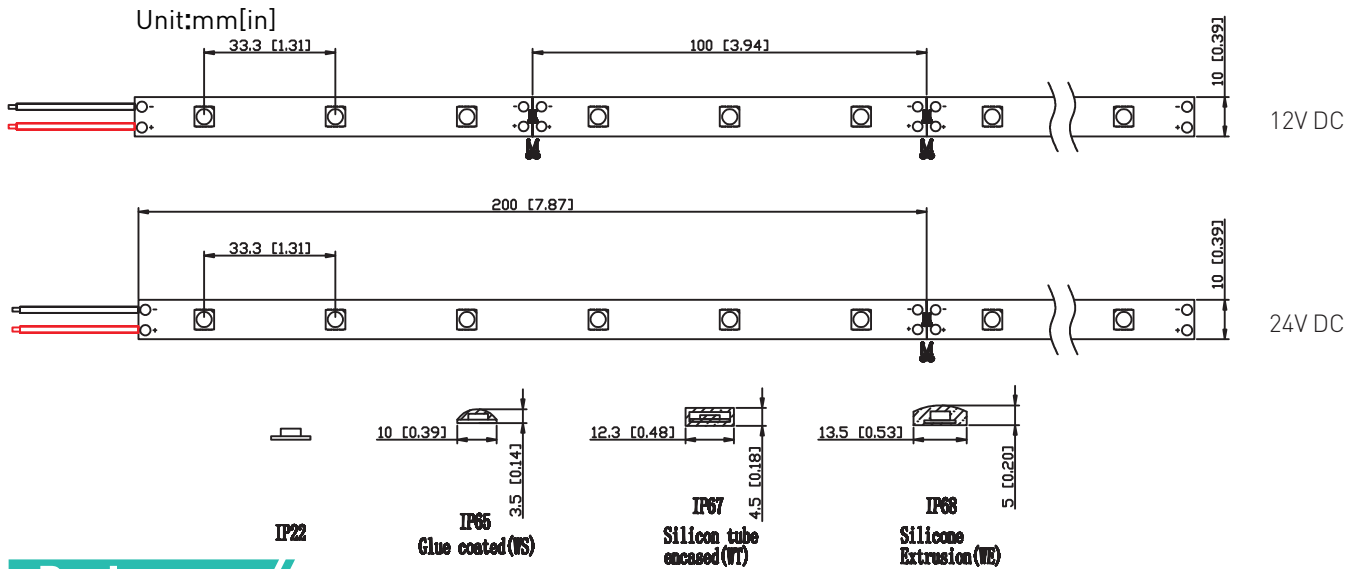

Package

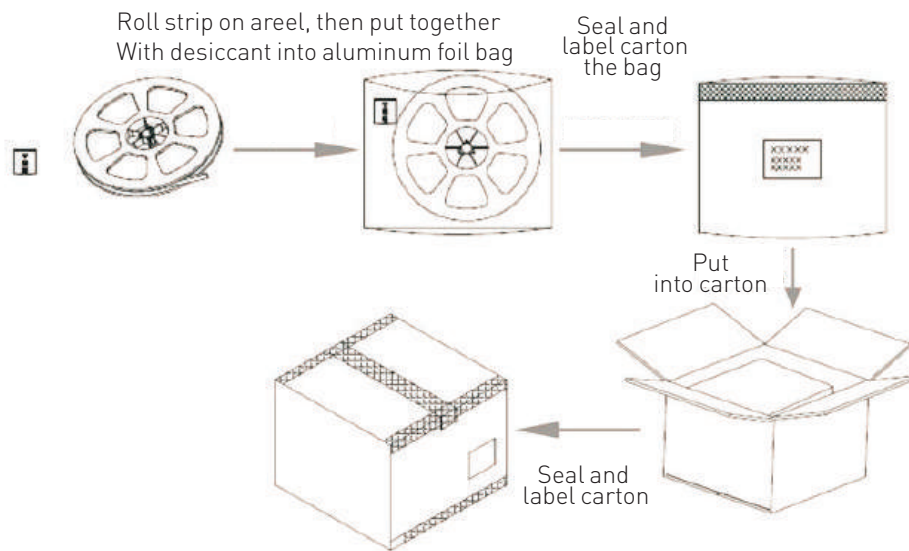

Packing Info

Order Code	Net Weight / CTN	Gross Weight / CTN	Units / CTN	Carton Size
FN-5050A-30	16.5(±10%) kgs	17.5(±10%) kgs	100 rolls	550*400*340mm

BLUEVIEW ELEC-OPTIC TECH CO.,LTD

Tel: +86-28-8148 0011 Fax: +86-28-8148 1258
 Mail: sales@blueviewled.com Web.: www.blueviewled.com
 Add: No.1000, Section 2, 2nd Konggang Road, Southwest
 Aviation Industrial Development Zone, Chengdu, Sichuan, China.
 Zip code: 610207

Specifications are subject to change without notice.
 © Blueview™ 2016 – All rights reserved. Made in China.