



# HONG SERIES

## DIRECT&INDIRECT PENDANT LINEAR LIGHT

HONG P / M / W Direct&Indirect is a linear LED lighting fixture that features direct and indirect lighting. Fixture features 95+, 90+ or 80+ LM80 LEDs. White color from 2700K to 6500K.

Dimmable driver available in Dali, 0/1-10V type, also controllable options in DMX, PWM and 2.4G Static, Tunable white, RGBW solution available.

The fixture is designed in multiple installation in Sus-pendant, Wall / Ceiling Mounted / Trimless / Trimmed Recessed. Fixture lengths are available in 2ft, 4ft, 5ft and 8ft, and custom lengths are available in 19.6ft.

### Finish

Aluminum clear matt anodized  
White / Black powder coating  
Customized RAL color available

### Applications

Indoor - Office, Commercial, Educational Institutions, Conference Rooms and many other workspaces.

# HONG SERIES

DIRECT&INDIRECT SURFACE LINEAR LIGHT

UGR  
<19



### Multiple Installation

- Pendant
- Wall Mounted
- Ceiling Mounted



### Die-casting Endcaps

Anti-light leaking design

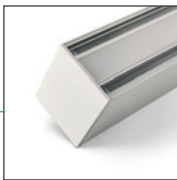

### Indirect Light

- Clear Lens
- Diffuser Lens

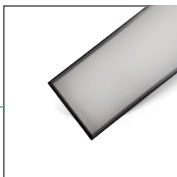

### Optical options

- Anti-Glare Film, UGR<19
- Rolling PC Lens up to **25m/pc**



### Sensor Optional

Microwave Sensor  
IR Sensor  
Timer

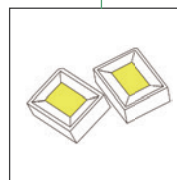

### High Quality Lighting

LM-80 Tested LED  
ONE-BIN only  
High R9, R15 value

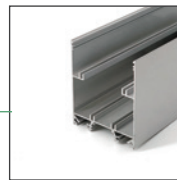

### Most comparable driver space

up to W2.4 x H1.38in



### 6063 Aluminum

Silver / Black clear matt anodize  
White/Black matt powder coating  
Customized RAL color available

# HONG SERIES

DIRECT&INDIRECT SURFACE LINEAR LIGHT

## ORDERING INFORMATION

LUMINAIRE	FINISH	LENS	LENGTH	COLOR QUALITY <sup>1</sup>	COLOR TEMP <sup>2</sup>	CRI	INSTALL ACCS.	IP GRADE	CONTROL OPTOINS
H7590 Direct & Indirect Linear Light	W White	U UGR<19 Kit	2 - 608mm	3	27 - 2700K	80	P Aircraft cable pendant	22 IP22	D1 - DALI  D2 - 0-10V  D3 - On/off
	B Black	D Diffuser	4 - 1208mm	3-Step MacAdam Ellipse	30 - 3000K	80+ CRI	W Wall Mounted		
U7590 Direct Linear Light	S Silver		5 - 1508mm	5 5-Step MacAdam Ellips	35 - 3500K	90	M Ceiling Mounted		
			8 - 2408mm		40 - 4000K	90+ CRI			
					50 - 5000K	95			
					60 - 6000K	95+ CRI			
					65 - 6500K				

1. Blueview's standard is 3-Step MacAdam

2. The listed Color Temperature is only available in CRI80+ in Epistar Chips, for 95+, 90+ in Epistar and Sumsung chips, pls. check the list on following page. For more options, pls. check with your executive sales.

## SPECIFICATION

Voltage	220-240 VAC / 100V-240 VAC			
Width / Height	75mm x 90mm			
Length	608mm	1208mm	1508mm	2408mm
Power (W/m /ft)	28 W/pc	56 W/pc	64 W/pc	112 W/pc
Efficacy Up to	85lm/w	90lm/w	90lm/w	90lm/w
Control	Dali , 0-10V, on/off			

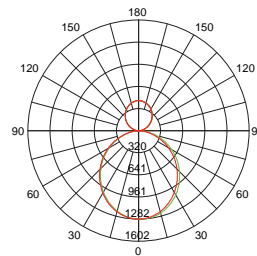

Direct&Indirect Lighting

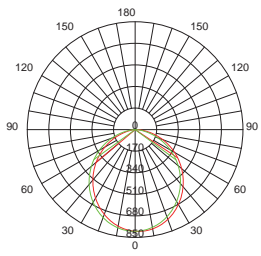

Direct Lighting

## INSTALLATION

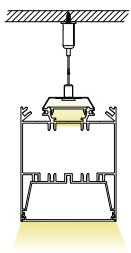

Direct&Indirect  
Pendant

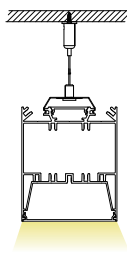

Direct Pendant

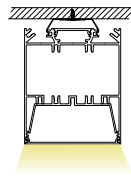

Ceiling Mounted

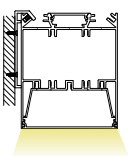

Direct  
Wall Mounted

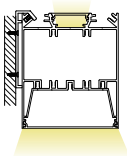

Direct&Indirect  
Wall Mounted

## ACCESSORIES



Wall Mounted Kit



Ceiling Mounted Kit



Aircraft Cable Pendant Kit

## SPECIFICATIONS

	Color Temperature	Lumen / Length			
RA 80	2700K	2161lm / 0.6m	4321lm / 1.2m	4938lm / 1.5m	8642lm / 2.4m
	3000K	2274lm / 0.6m	4549lm / 1.2m	5198lm / 1.5m	9097lm / 2.4m
	3500K	2394lm / 0.6m	4788lm / 1.2m	5472lm / 1.5m	9576lm / 2.4m
	4000K	2520lm / 0.6m	5040lm / 1.2m	5760lm / 1.5m	10080lm / 2.4m
	5000K	2520lm / 0.6m	5040lm / 1.2m	5760lm / 1.5m	10080lm / 2.4m
	6000K	2520lm / 0.6m	5040lm / 1.2m	5760lm / 1.5m	10080lm / 2.4m
	6500K	2520lm / 0.6m	5040lm / 1.2m	5760lm / 1.5m	10080lm / 2.4m
RA 90	2700K	1728lm / 0.6m	3457lm / 1.2m	3951lm / 1.5m	6914lm / 2.4m
	3000K	1819lm / 0.6m	3639lm / 1.2m	4159lm / 1.5m	7278lm / 2.4m
	3500K	1915lm / 0.6m	3830lm / 1.2m	4378lm / 1.5m	7661lm / 2.4m
	4000K	2016lm / 0.6m	4032lm / 1.2m	4608lm / 1.5m	8064lm / 2.4m
	5000K	2016lm / 0.6m	4032lm / 1.2m	4608lm / 1.5m	8064lm / 2.4m
	6000K	2016lm / 0.6m	4032lm / 1.2m	4608lm / 1.5m	8064lm / 2.4m
	6500K	2016lm / 0.6m	4032lm / 1.2m	4608lm / 1.5m	8064lm / 2.4m
RA 95	2700K	1555lm / 0.6m	3110lm / 1.2m	3556lm / 1.5m	6222lm / 2.4m
	3000K	1637lm / 0.6m	3274lm / 1.2m	3743lm / 1.5m	6449lm / 2.4m
	3500K	1723lm / 0.6m	3447lm / 1.2m	3940lm / 1.5m	6894lm / 2.4m
	4000K	1814lm / 0.6m	3628lm / 1.2m	4147lm / 1.5m	7257lm / 2.4m
	6500K	1814lm / 0.6m	3628lm / 1.2m	4147lm / 1.5m	7257lm / 2.4m
SAMSUNG RA 80	3000K	2047lm / 0.6m	4094lm / 1.2m	4679lm / 1.5m	8187lm / 2.4m
	4000K	2268lm / 0.6m	4536lm / 1.2m	5184lm / 1.5m	9072lm / 2.4m
	6500K	2268lm / 0.6m	4536lm / 1.2m	5184lm / 1.5m	9072lm / 2.4m

### Note:

- The given data are typical values in PC Diffuser. Due to tolerances of the production process and the electrical components, values for light output and electrical power can vary up to 10%.
- 15% less on luminous flux at Traic driver, DALI and 0/1-10V driver, and -10% Non-Dim driver.
- 10% less on UGR<19 version.
- Above data based on Non-Dimmable for all luminaires.
- More customized LED and CCT available.
- LM-80, IES TM-30-15 testing report available for led.

## DIMENSIONS

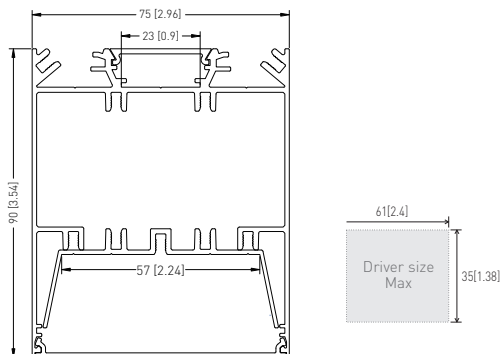

Unit:mm[in]

## LED CHIPS AND DRIVER OPTIONS

