

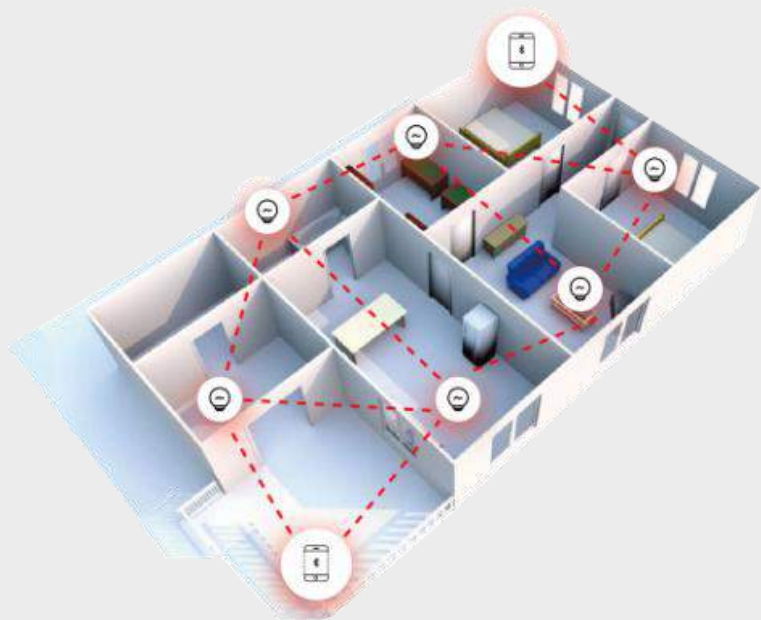

LED Lighting Smart Control System

Patent Pending

Blueview Elec-optic Tech Co.,LTD



Blueview LED Lighting Smart Control System

To meet the personalized and freewheeling needs of controlling lighting appliance, Blueview develop this system on the base of the newest technology launched by bluetooth association recently. This system is an integrated smart lighting system, controlling Blueview display light appliance through BL-CV4 controller by multiple ways.

LOGO

LOGO



Logo

Applications



Shelf in
Supermarket



Display case in
Mall



Office Lighting



Entertainment
Venue Lighting



House Lighting

System Structure

LED Lighting Smart Control System

Control Center

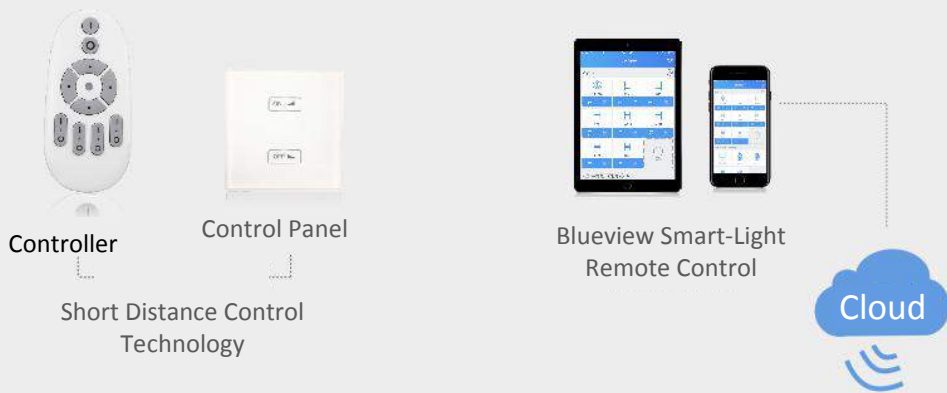

Signal Convert



Front-end control devices



LED Light Smart Control System--- Short Distance Control

No need to setup, control
immediately once power is on

Short distance control
近程控制



Remote Controller

遥控器



Control Panel

面板



LED Light Smart Control System--- remote control freewheeling, get rid of space restriction



Connection Diagram

BV-CV4 devices Max Connection in one system ≤65535 pcs
 BV-CV4 devices Max connection in one group ≤255 pcs

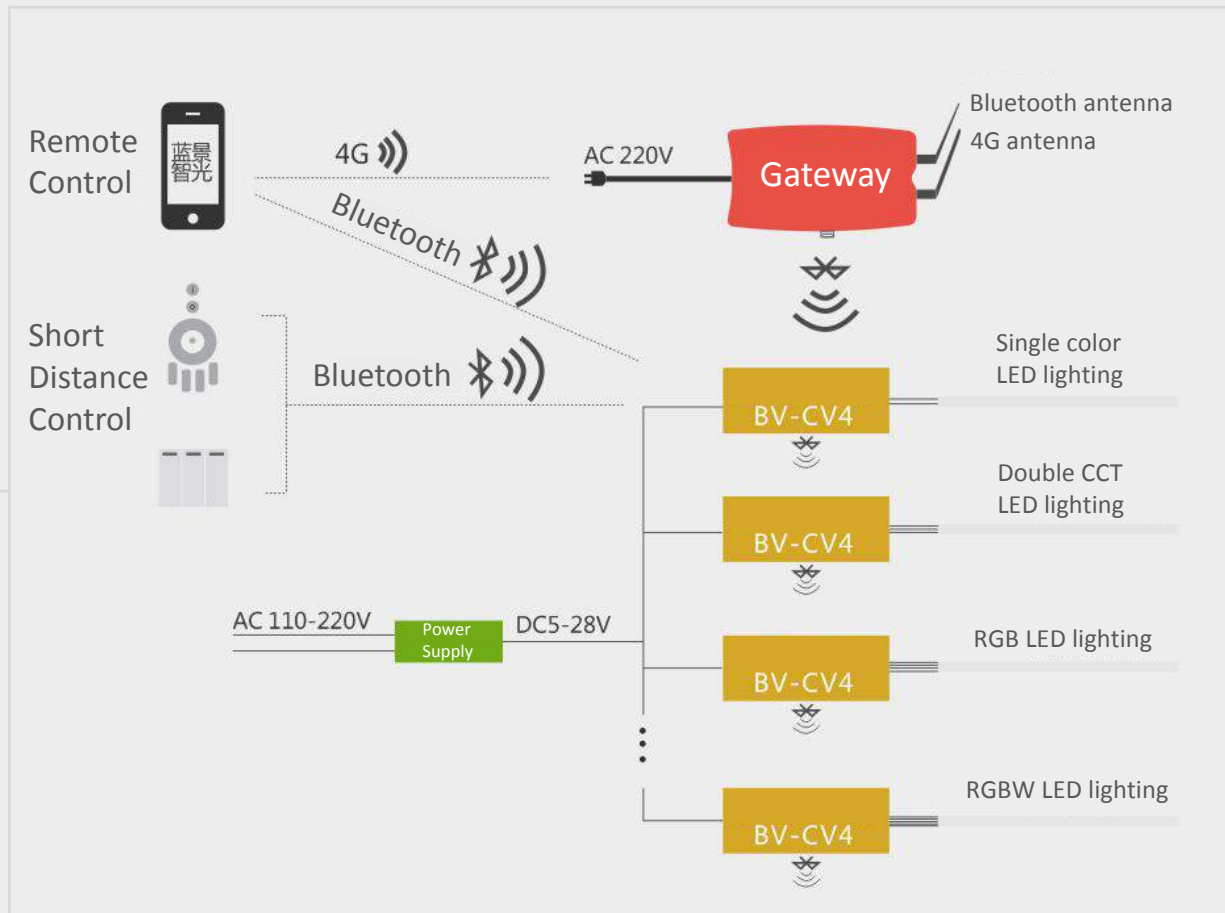

System Devices

LED Lighting Smart Control System

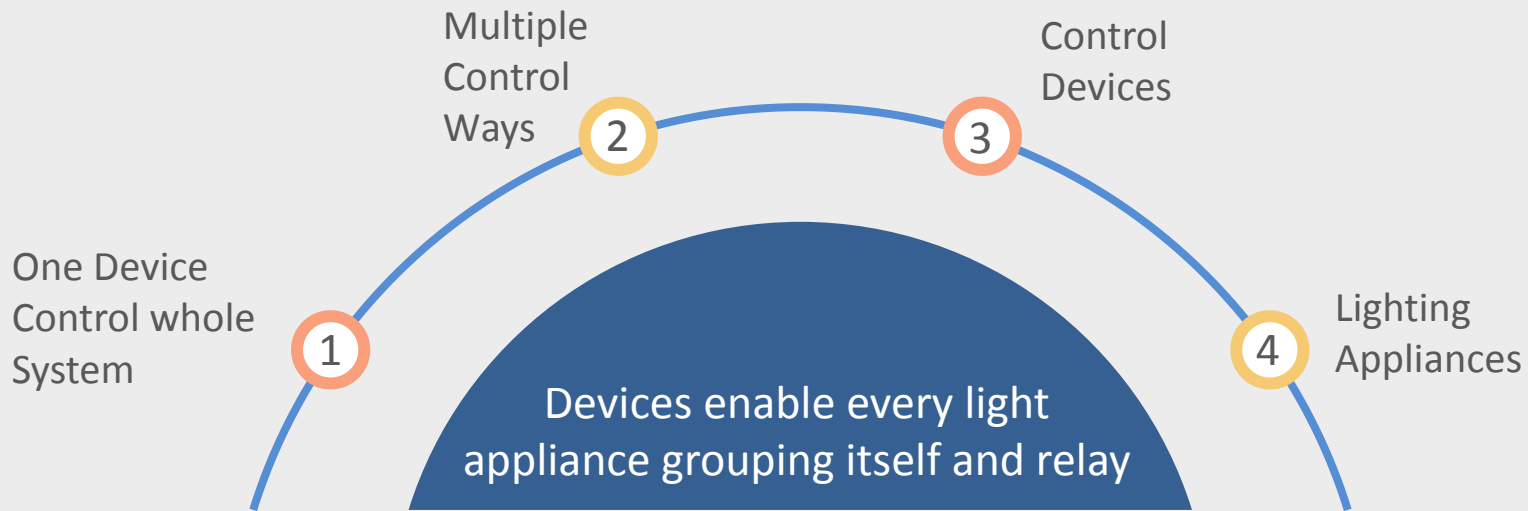



① Remote Controller

- Directly control BV-CV4
- Can divided into 4 groups
- Dimmable and CCT controllable in groups
- Can join or quit the set-up group

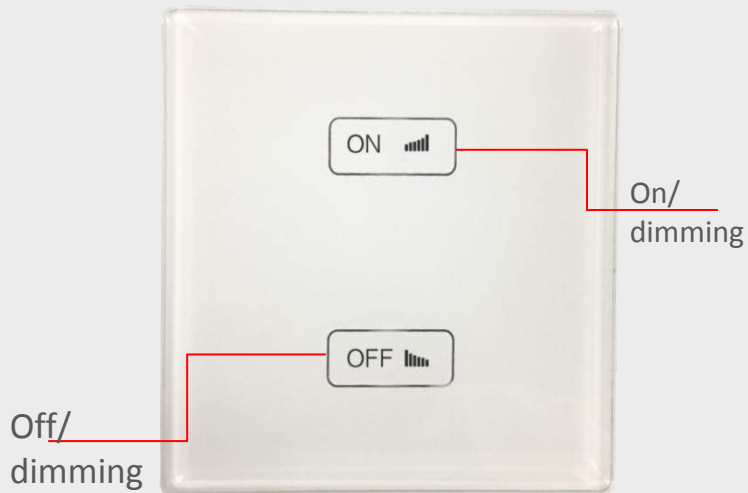

② Panel Control

- Can control directly of BV-CV4
- No wire, free location
- Dimmable and CCT controllable in groups
- Can join or quit the set-up group



③ BV-CV4 Self-grouping Devices

- BV-CV4 is based on latest technology launched by Bluetooth association recently. Working with supporting APP, control Blueviews' LED lighting through Bluetooth.
- BV-CV4 can control single color ,double CCT,RGB&RGBW constant voltage LED lighting.
- 5-28V input, 5 output ports for the above 4 different kinds of LED lighting, total rated power is up to 250w.
- Max connection numbers in one system is 65535pcs, Max connection numbers in one group is 255pcs.



④ Gateway

- Residential electricity
- IP67 waterproof
- 4G IoT card. No need internet
- Can be replaced by router



System APP

LED Lighting Smart Control System

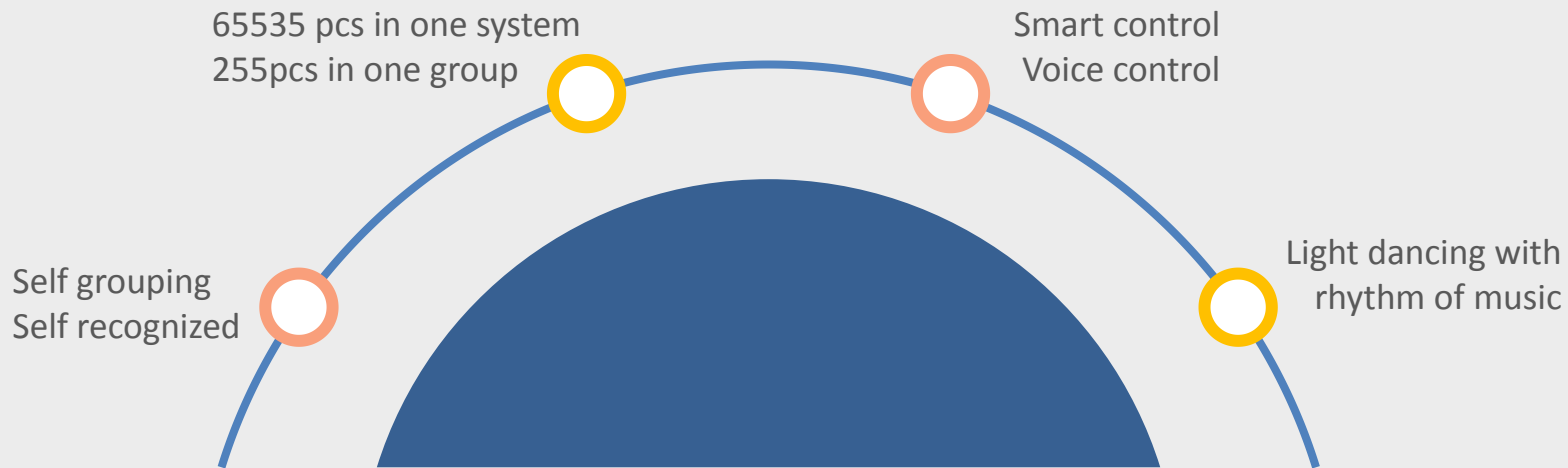



Scan the QR Code,
Download Blueview
Smart Lighting APP



APP
Homepage



A/C setup



Group name



Shelf image



Shelf name



Shelf rename

10 Dimming Modes



Integral dimming

No need to set up, it can control all lights.
The lights can group by themselves.



Breathing mode

Including: rainbow breathing, heart beat,
green breathing, blue breathing, alert,
twinkling, RGB color breathing, green mood,
sunset . etc



Music

Light color will be changed with the rhythm of music.



Children Game

This game mode has 8 colors, when children choose the
picture, the light will change to the color of picture, and
it has voice interaction.



Day&night mode

This mode has day and night two modes, you can
set up the light according to the lighting hours.



Voice control

This mode is working under internet, 4G or Wifi;
Strong voice analysis function enables accurate
control of lights in the whole system.



Color dip

Light color will change to the color through your
mobile camera under this mode.



Shake

This mode has two effects, one is dancing, lights will
change according to the dance, the other is color can
change when shaking the mobile.



Shooting game

In this game, every cannonball is one color, light
color will change according to the ball color when
you shoot the ball.



Timing

Set up the light time in this mode.



Single color
Dimming

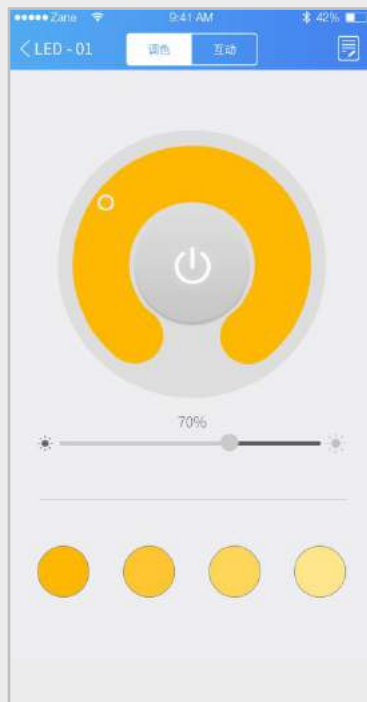

Double CCT
Dimming



RGB
Dimming

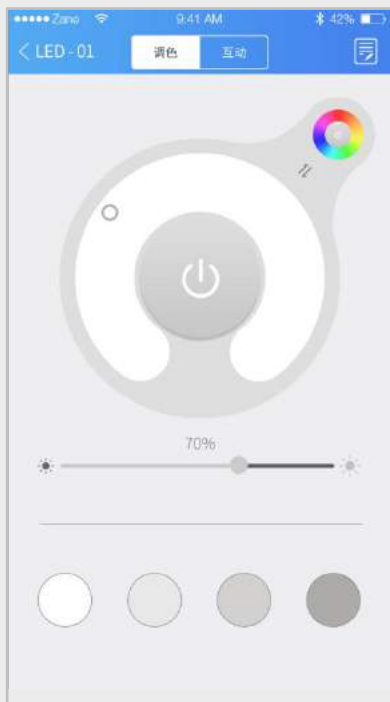

Switch in dimming



Interaction mode

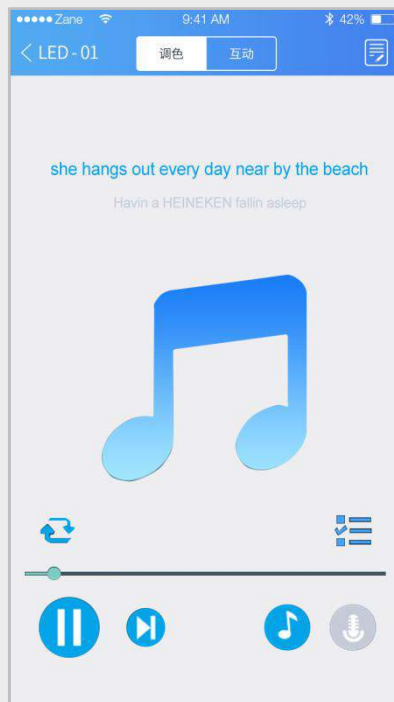

Light dancing
with music



Voice control

System Applications

LED Lighting Smart Control System



Scenes:

1. Forget to turn off the light before leaving from house. You can turn off the light through remote control system.
2. When storekeeper wants to do the sales promotion on one item, he can change the LED lights to low CCT temperature, to make this item attractive.



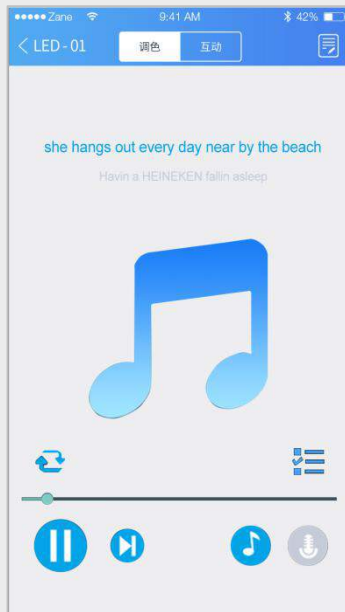

Scenes:

3. Light dancing with music can attract more visitors, which will increase visitors flowrate tremendously, especially for KTV & club.



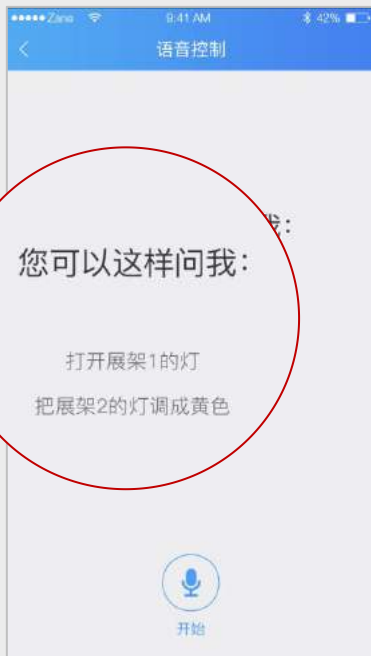

Scenes :

- Using voice control to control all the lights in the mall, save time on turning on/off the lights one by one.



Recommend Products

LED Lighting Smart Control System



120dots/m 2835 Tape light

1. 14.4w/m
2. Light efficiency up to 100lm/w
3. 1200-1464lm/m
4. 5/3/2 years warranty

High Efficiency Tape Light 5730SMD

1. 24V Input
2. 130 lm/w
3. 64 dots/m & 128 dots/m available,
1267-1497lm/m & 2534-2995lm/m
4. 5 years warranty

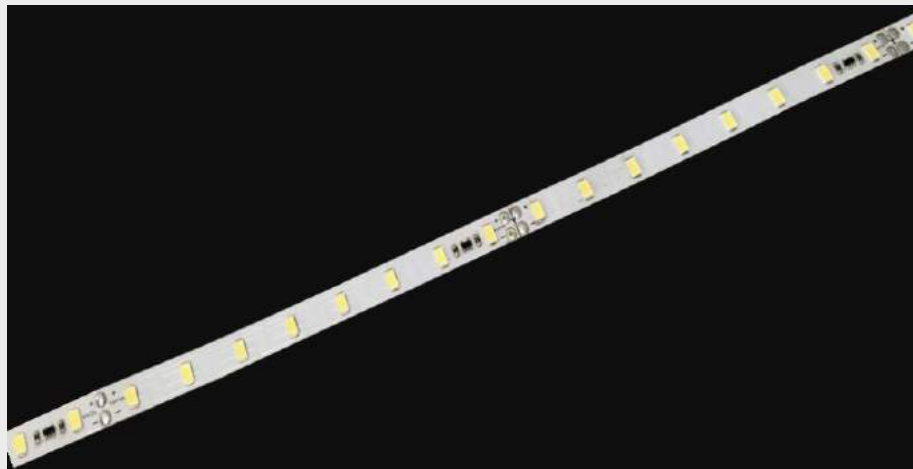



2016 SMD Double CCT Tape Light

1. 12v/24v Input
2. 180 dots/m & 240 dots/m available
3. Two colors in one tape
4. 5 years warranty

RGB Tape Light

1. 30 dots/m & 60dots/m available
2. RGB color 3in 1 5050 SMD
3. 4/3/2 years warranty





RGB+W Tape Light

1. 30RGB dots/m+30 white dots/m
2. RGB & white color available in one tape
3. 4/3 years warranty



RGBW/RGBA Tape Light

1. RGBW/RGBA 4 in 1 60 dots/m
2. 19.2w/m
3. 4 years warranty

RECOMMENDATION FOR LINEAR LIGHT ENGINE

DIRECT LIGHTING

Light Engine Code	LED /m	Power/m	Lumen/m	Efficiency	FPC Width	Cuttable	Controllable	Suitable Profile (Hot-spot less, Diffuser PC Cover)
FN-2016-240	240pcs	17.29w	1162-1470lm	66lm/w	18mm	12V±12.5mm	DMX, DALI Dimmable	Width: 12-35mm, Light Engine to Cover Depth: 5-35mm
FN-2016-266	266pcs	16.42w	1310-1437lm	80lm/w	18mm	24V±26.3mm	DMX, DALI Dimmable	
FN-2016-240-Dual	240pcs	17.29w	1256-1404lm	68lm/w	18mm	12V±25mm 24V±50mm	DMX, DALI, CCT Dimmable	
FN-3528-12V-3W/PCW	120pcs	9.6w	671-695lm	68lm/w	8mm	12V±50mm 24V±100mm	DMX, DALI, CCT Dimmable	
FN-4020S-120	120pcs	11.52w	1380-1680lm	130lm/w	18mm	24V±2.5mm	DMX, DALI Dimmable	Width: 12-35mm, Light Engine to Cover Depth: 12-35mm
FN-4020S-160	160pcs	14.4w	1696-2230lm	130lm/w	18mm	24V±25mm	DMX, DALI Dimmable	
FN-3020A-120	120pcs	14.4w	1300-1464lm	100lm/w	18mm	12V±25mm 24V±50mm	DMX, DALI Dimmable	
FN-3528A-120	120pcs	9.6w	480-480lm	65lm/w	8mm	12V±25mm 24V±50mm	DMX, DALI Dimmable	
FN-2016A-162	162pcs	9.36w	720-830lm	85lm/w	8mm	29.5mm	DMX, DALI Dimmable	

IN-DIRECT LIGHTING (All direct light engines are suitable)

FN-H2835-64	64pcs	7.68w	92-1070lm	130lm/w	18mm	24V±125mm	DMX, DALI Dimmable
FN-H2835-80	80pcs	9.6w	3050-1365lm	130lm/w	18mm	24V±100mm	DMX, DALI Dimmable
FN-2835A-60	60pcs	14.4w	972-1454lm	90lm/w	18mm	12V±50mm 24V±100mm	DMX, DALI Dimmable
FN-3528A-60	60pcs	6.0w	243-405lm	60lm/w	8mm	12V±60mm 24V±100mm	DMX, DALI Dimmable
FN-5630-60	60pcs	20w	1800-2000lm	95lm/w	18mm	24V±100mm	DMX, DALI Dimmable

YU5 LED Bar for Display Box

1. Adopt high efficiency 2835 LED
2. Aluminum profile for heat diffusion
30leds in 0.5 meter, 60 LEDs in 1meter,
90leds in 1.5meter
3. Application in cabinet and display box.





Thank you

Blueview Elec-optic Tech Co.,Ltd