

## Features

- High efficacy
- Adopt integrated lens
- Full glue coated, can be directly used for outdoors
- Single module can be cut

## Application

- Suitable for 5-18cm deep light box, advertising letters, outdoor lighting, etc

## Installation

- Fix by adhesive tape or screws



### Optical & Electrical Parameters

| Model No. | Light Color | CCT/Color Available (K/nm) | Beam Angle | Luminous Flux (lm/pcs) | Ra  | Efficacy (lm/W) | Voltage (V DC) | Power (W/pcs) |
|-----------|-------------|----------------------------|------------|------------------------|-----|-----------------|----------------|---------------|
| QG05      | W           | 9000-10000                 | 180°       | 132                    | 80+ | 110             | 12             | 1.2           |

### Other Parameters

| Model No. | LED Qty/pc | Product Size L*W*H(mm) | Standard Packing Quantity(pcs) | Max Run(pcs) | Working Temperature | Storage Temperature |
|-----------|------------|------------------------|--------------------------------|--------------|---------------------|---------------------|
| QG05      | 3          | 60*16*9.8              | 75                             | 75           | -20~+60°C           | -20~+70°C           |

**NOTE:**

1. Testing temperature: 25±2°C
2. The above data are typical values. The actual data of each single product may differ from the typical values. The data is subject to change without notice.
3. Different color temperature will make luminous flux different.
4. The "Quantity" above means the LED quantity of single module.
5. Luminous flux & power tolerance within ±10%.
6. Max. cascading length is powered one end.

### Profile Drawings

Unit:mm

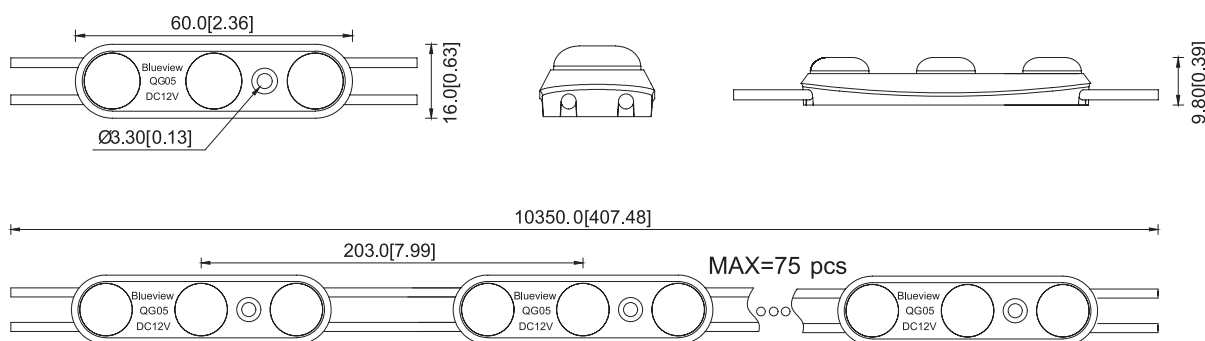

Note: for detail drawing, please consult sales rep.



Luminous Intensity Distribution Diagram

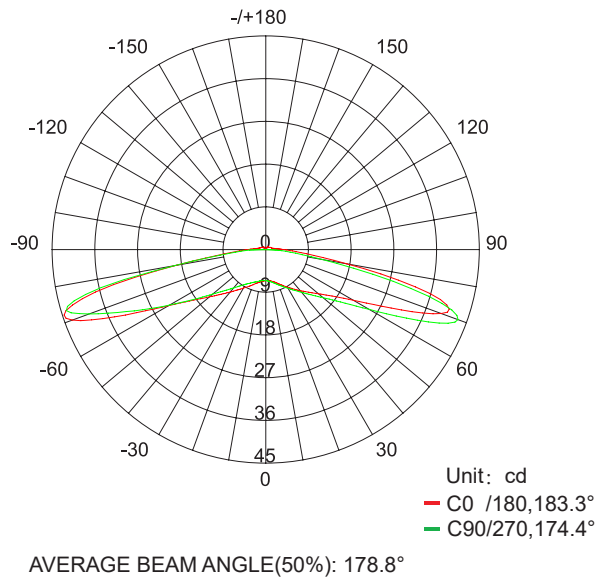

Average Illumination

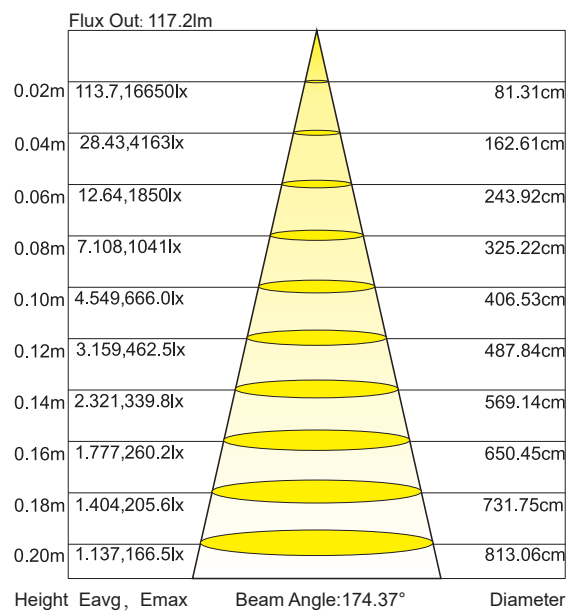

Note: The above two figures are tested with the sample QG05 for other data, please consult sales rep.

Reliability Test

| Test Sort          | Test item                       | Reference Standard               | Test condition  | Test result |
|--------------------|---------------------------------|----------------------------------|---|-------------|
| Environmental test | PTC test                        | Blueview Product Warranty Policy | TH=-60°C/15M, TL= - 40°C /15m per times (temperature rise and fall for 45 minute) | PASS        |
|                    | Room temperature aging test     |                                  | TH=80°C/4h, TH= - 40°C /4h continuous lightened up                                |             |
|                    | High temperature resistant test |                                  | TH=80°C, continuous lightened up  |             |
|                    | Room temperature aging test     |                                  | Ta=25°C, continuous lightened up  |             |

packing

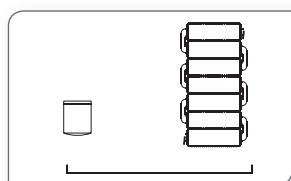

Prepare the desiccant and bind the product.

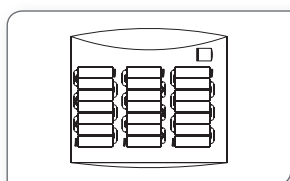

Put neatly placed products into anti-static shielding bags

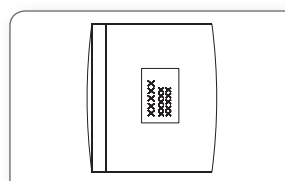

Seal and label the static shielding bag.

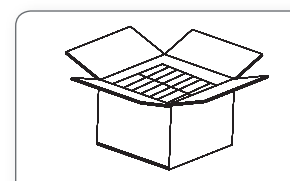

Put the static shielding bag side by side into carton box.

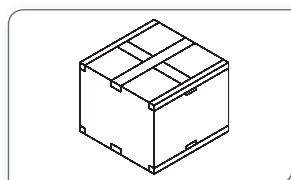

Seal the box.

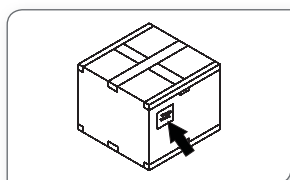

Seal the the carton and label accordingly.

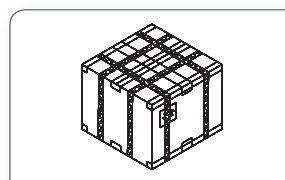

Use packing belt to pack after adding the edge protectors.

Packaging information

| Model No. | Product Size L*W*H(mm) | Carton Size(mm) | pcs/bag | bag/Carton | Net Weight(kg) | Gross Weight(kg) |
|-----------|------------------------|-----------------|---------|------------|----------------|------------------|
| QG05      | 60*16*9.8              | 390*390*325     | 75      | 16         | 15.08(1±10%)   | 16.55(1±10%)     |

Note:

The above quantity and weight are only for the illustrated packaging method. There will be differences in the quantity and weight with other packaging methods.



## Installation

### Connection Diagram

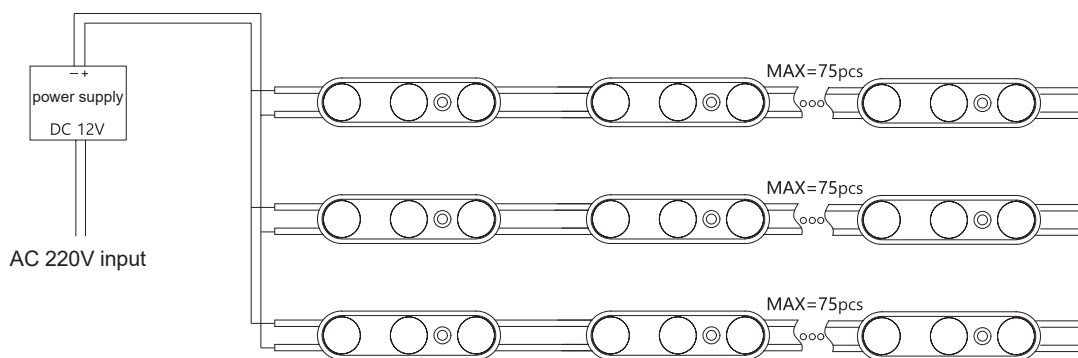

### Installation Reference

| Model No. | Surface Material | Depth(H)cm | Illumination(lux) | Evenness | Density (pcs/m <sup>2</sup> ) | Spacing (X*Y)cm | Watt Density (W/m ) | Visual Effects |
|-----------|------------------|------------|-------------------|----------|-------------------------------|-----------------|---------------------|----------------|
| QG05      | White Soft Film  | 5          | 13300-15640       | 0.85     | 12*12                         | 8*8             | 173                 | OK             |
|           |                  | 6          | 8220-9670         | 0.85     | 10*10                         | 10*10           | 120                 |                |
|           |                  | 8          | 4830-5780         | 0.84     | 8*8                           | 12*12           | 77                  |                |
|           |                  | 10         | 3640-4260         | 0.85     | 7*8                           | 14*12           | 67                  |                |
|           |                  | 12         | 3110-3480         | 0.89     | 7*8                           | 14*12           | 67                  |                |
|           |                  | 15         | 2360-2590         | 0.91     | 7*8                           | 14*12           | 67                  |                |
|           |                  | 18         | 1960-2120         | 0.92     | 7*8                           | 14*12           | 67                  |                |

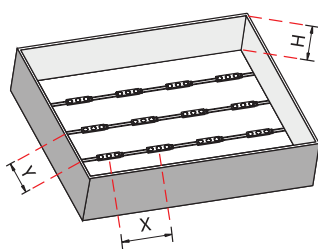

### Note:

1. X indicates the horizontal center spacing between modules;
2. Y indicates the longitudinal center spacing between modules;
3. Single LED modules are arranged in a square, X=Y.
4. When the depth of light box H>18cm, use more products to satisfy illumination demand
5. Please contact the sales for other data.
6. Customized wire length available.
7. The above data is for common demand , you can increase the density for actual demand.

### Accessories & Tools

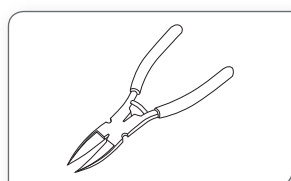

Diagonal Pliers

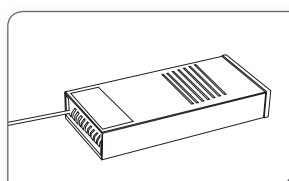

LED power supply

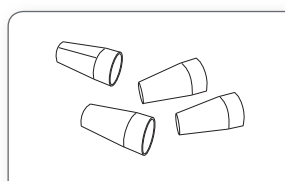

Connection Terminals



## Installation steps

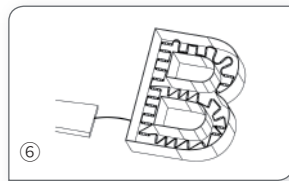
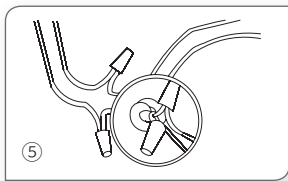
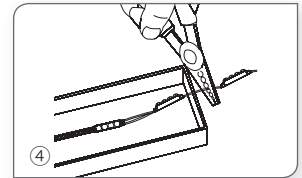
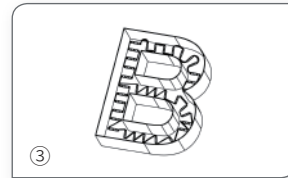
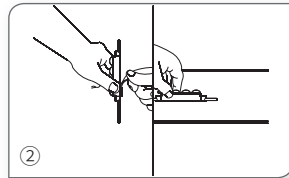
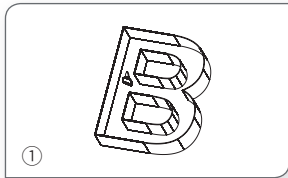

- 
- 1.Clean the mounting surface.
  - 2.Peel away the release paper on the back of led modules and stick them onto mounting surface.
  - 3.Evenly arrange the led modules with appropriate space.
  - 4.Cut the modules according to the requirements and treat the cut place with insulation and waterproof arrangement.  
Note: Cut in the middle of the wire.
  - 5.If the product needs to be connected, it is better to fix with connection ends.  
Note: Treat the thread with insulation,waterproof, and anti-corrosion arrangement as it cannot pull out by hands.
  - 6.Make sure the correct connection of positive and negative poles between led module and power supply.  
Note: Treat the thread with insulation,waterproof, and anti-corrosion arrangement as it cannot pull out by hands.
-



## Attentions before installation

Before installation, check that the product parameters are consistent with the requirements (Seeing product specifications or product labels) Load voltage, current, power and power supply should be matched with the product.

Follow the instructions of wiring diagram (first connect the load and then the power supply) to avoid short circuit.

Make sure the correct connection of positive and negative poles between products and power supply. Otherwise, the light will not be on.

Make sure the power cord firmly screwed into the terminal and it should not be pulled out by hands.

The terminal should have insulation,waterproof and anti-corrosive treatment.

If the working length exceeded the max run length, make sure to have extra power supply.

If it needs higher current of a LED, make sure having extra cooling.

## Common Faults and Troubleshoot

| Quick Guide   |  |  |
|---|--|--|
| Problems  | Reasons  | Solutions  |
| All LEDs can not light on.                          | No electric supply.  | Power on   |
|   | Automatic power protection from the open or short circuit in output of the power supply. | Fix the short circuit problem.   |
|   | Wrong connection of power supply.  |  |
| LEDs can not light on partly.                       | Some switching mode power supplies are not powered.                                      | Check the power supply system to fix it.   |
|   | Power supply line error.   |  |
|   | Mistaken wire connection of some of products   | Correctly connection   |
| Brightness of LED is inconsistent tor insufficient. | Power overloaded.  | Replace with more powerful power   |
|   | Power supply circuit excessive consumption.  | Make sure the working voltage of the product within $\pm 5\%$ of standard voltage, or keep balance by circuit power consumption. |
|   | Excessive quantities in series connection of the product                                 | Reduce the quantities of the product in series connection to meet requirement.   |
| LED flicker.  | Connection point fault.  | Remove bad connection point.   |
|   | Switching power supply failure.  | Replace a new power supply.  |
|   | Wrong Installation or use of products  | Please follow the instructions   |

### **Warning**

- Do not disassemble or retrofit the light. Do not touch the surface of the light with a sharp object.
- Do not do live-line working during installation,especially for high voltage product.
- Do not use any organic chemical solvents.
- Use neutral glass adhesive to fix this product and it needs to be dried 4 hours in the open environment after operation.
- Treat the ends and the circuit connection points that are not connected to the main line with insulation,waterproof, and anti-corrosion in the installation.
- Use 18AWG (0.75mm<sup>2</sup> cross-sectional area) or thicker core wire to avoid adverse consequences caused by overheating, if the power cable need to lengthen.
- Make sure the input voltage meets the requirements and lines are connected correctly before lighting on.
- This product is for signage, and do not use as general lighting.
- Series connection within the max run.
- The length of the power cable between the power supply and the led strip should not exceed 2 meters.Otherwise, large circuit loss will lead to inconsistent brightness.
- Installation, maintenance and repair should be operated by a qualified technician.

## Statements and Recycling

### Statements:

Repair should be operated by a qualified technician, if the external circuit or main line of this product is damaged.

The parameters given in this manual are typical values and for reference only.

All illustrations and drawings in this manual are for reference.

This product is subject to change without notice.

### Recycling:

LED lighting products belongs to electronic products, please do recycling treatment according to the relevant WEEE directives.