

SPI



Features

- Adopt integrated lens
- Great weather and UV resistance
- Can achieve reach color changes with external controller, such as MR-502 controller
- Single module can be cut

Application

- Applied for light box with depth 10-25cm, advertising letters etc.

Installation

- Fix by adhesive tape or screws



Optical & Electrical Parameters

Model No.	Light Color	CCT/Color Available (K/nm)	Beam Angle	Luminous Flux (lm/pcs)	Ra	Efficacy (lm/W)	Voltage (V DC)	Power (W/pcs)	
PQ8	W	6500	150°	10	80+	50	12	0.20	
	R	620-630		2				10	0.20
	G	520-530		6				30	0.20
	B	460-470		1				6	0.20
	RGB	/		18				30	0.60
	RGBW	/		/				/	/

Other Parameters

Model No.	LED Qty/pc	Product Size L*W*H(mm)	Standard Run(pcs)	Max Run(pcs)	Working Temperature	Storage Temperature
PQ8	3	65*22*11.2	30	30	-20~+60°C	-20~+70°C

NOTE:

1. Testing temperature: 25±2°C
2. The above data are typical values. The actual data of each single product may differ from the typical values. The data is subject to change without notice.
3. Different color temperature will make luminous flux different.
4. The "Quantity" above means the LED quantity of single module.
5. Luminous flux & power tolerance within ±10%.
6. Max. cascading length is powered one end.

Profile Drawings

Unit:mm[inch]

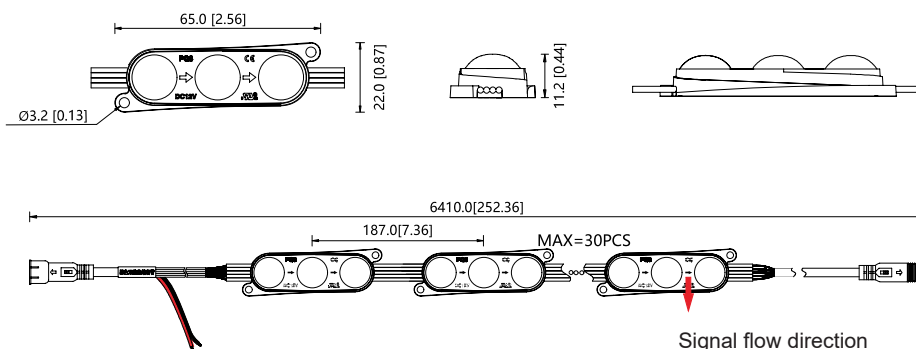

Signal flow direction

Signal flow direction: specify the flow direction from the controller to the outside

Note:

When in use, the controller must be connected to light up the product; if you need detailed dimensions, please contact sales Rep



Luminous Intensity Distribution Diagram

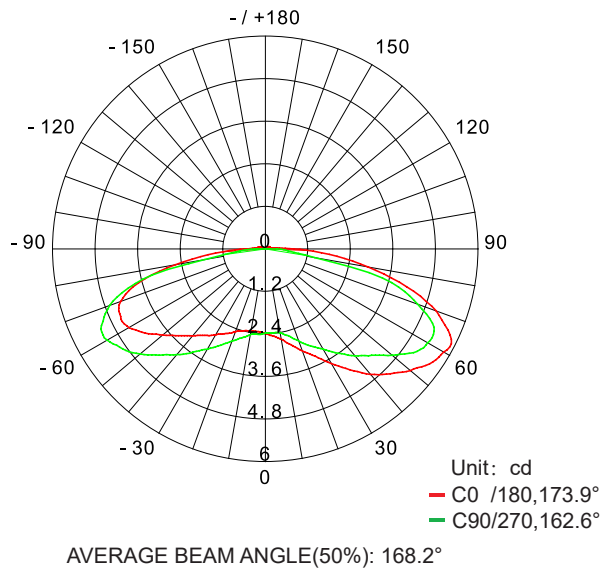

Average Illumination

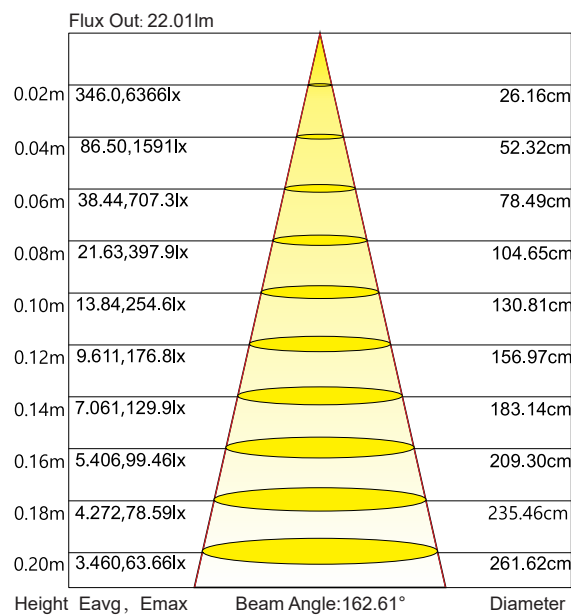

Note: The above data are obtained from PQ8-RGB. If you need data of other models, please contact the sales rep.



packing

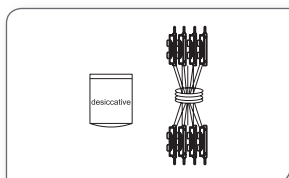

Prepare the desiccant and bind the product.

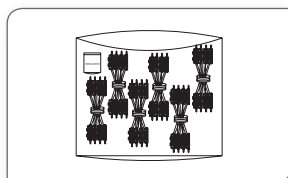

Put the product and desiccant into static shielding bag.

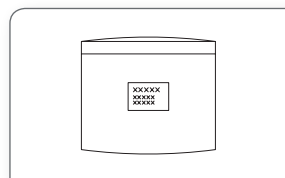

Seal and label the static shielding bag.

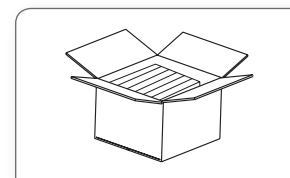

Put the static shielding bag side by side into carton box.

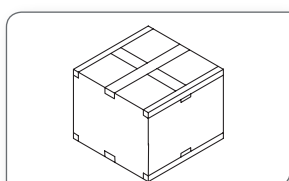

Seal the box.

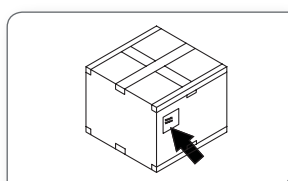

Label the box;

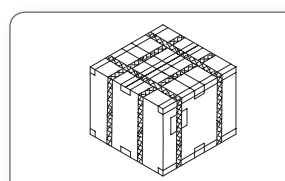

Use packing belt to pack after adding the edge protectors.

Packaging information

Model No.	Product Size L*W*H(mm)	Carton Size(mm)	pcs/bag	bag/Carton	Net Weight(kg)	Gross Weight(kg)
PQ8	65*22*11.2	390*390*325	60	16	14.05(1±10%)	15.45(1±10%)

Note:

The above-mentioned packaging quantity and weight are only for the packaging method shown in the figure. There will be differences in the packaging quantity and weight when other packaging methods are used. The above weight is an estimated weight and is subject to the actual product.

Installation

Connection Diagram

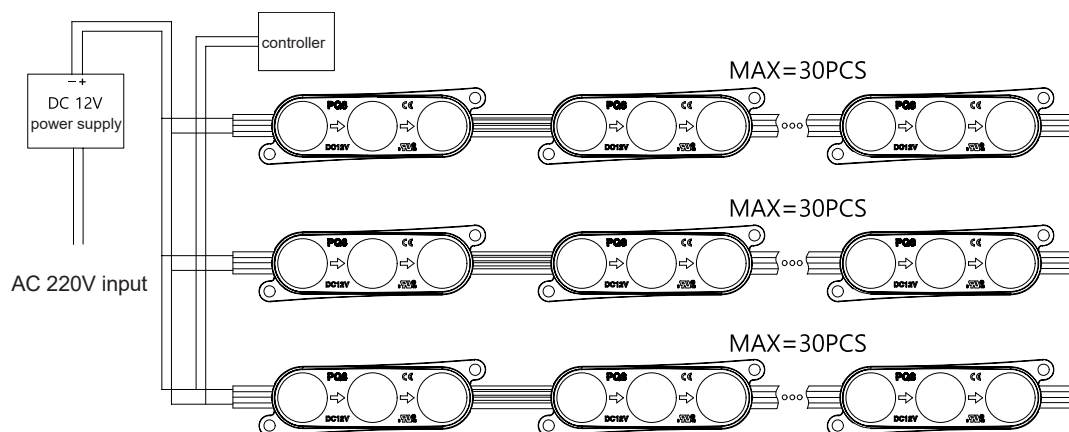



Installation Reference

Model No.	Surface Material	Depth(H)cm	Illumination(lux)	Evenness	Density (pcs/m ²)	Spacing (X*Y)cm	Watt Density (W/m)	Visual Effects
PQ8	White Soft Film	10	1287-1538	0.84	10*10	10*10	100	OK
		12	712-838	0.85	7*8	14*12	56	
		15	578-672	0.86	6*6	16*16	36	
		18	443-502	0.88	5*5	20*18	25	

Note:

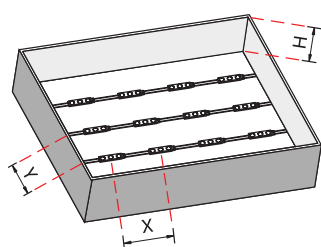

1. X indicates the horizontal center spacing between modules;
2. Y indicates the longitudinal center spacing between modules;
3. Single LED modules are arranged in a square, X=Y.
4. When the depth of light box H>18cm, use more products to satisfy Illumination demand
5. Please contact the sales for other data.
6. Customized wire length available.
7. The above data is for common demand , you can increase the density for actual demand.
8. The above data are obtained when four color of PQ8 are all bright

Connection Diagram of Controller

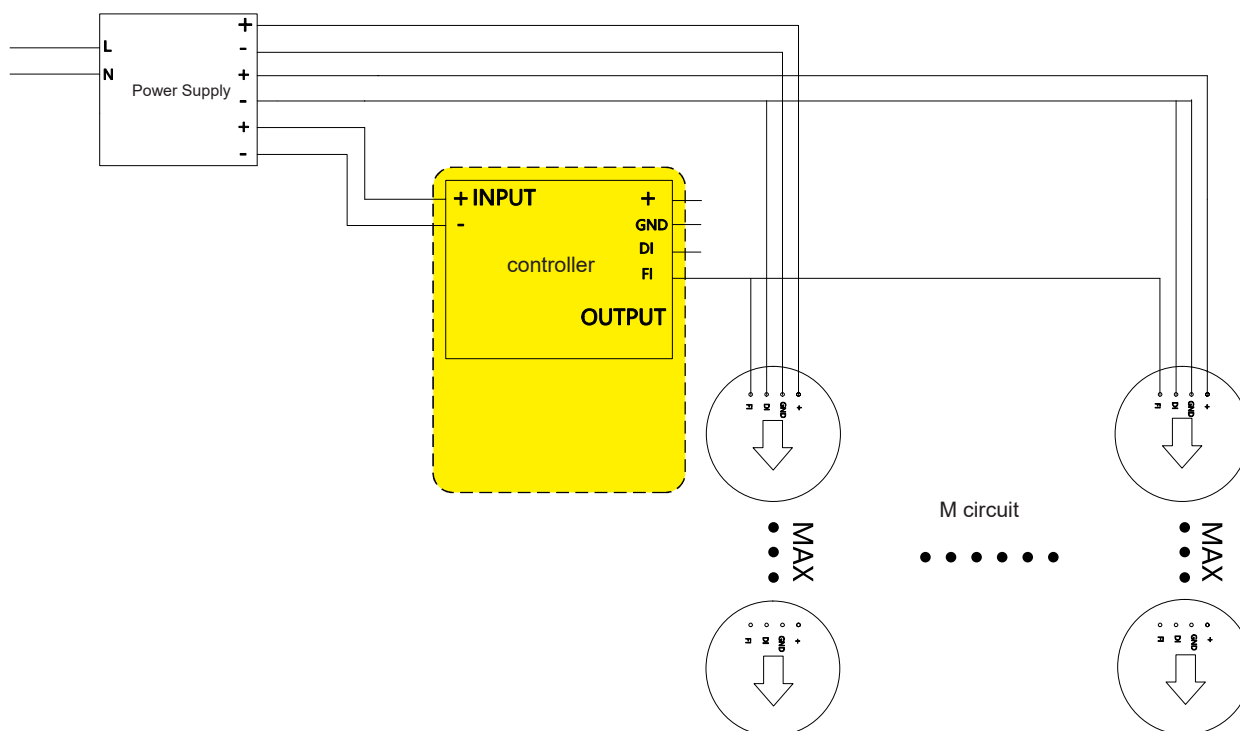



Power supply rated power (W): P Product

Module rated power (W): P(module)

Controller load: M(pcs)

Module max run: MAX=30

$$M = \frac{P \times 0.8}{P_{(\text{module})} \times \text{MAX}}$$

For example: the product is PQ8 of 0.80W, the max run MAX=30pcs, the power supply is 400W, so the controller load is

$$M = \frac{P \times 0.8}{P_{(\text{module})} \times \text{MAX}} = \frac{400 \times 0.8}{0.80 \times 30} \doteq 13 (\text{pcs})$$

Note:

Keep module closer to power supply. If can not, please use thick wires, which can avoid brightness difference, and each group of modules require separately power supply.

In order to limit the max current through controller, please avoid connecting negative and positive wire of the module to a controller.

Accessories & Tools

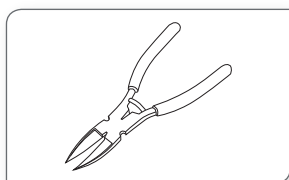

Diagonal Pliers

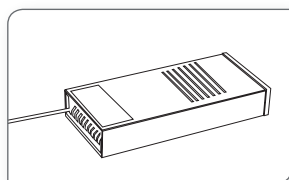

LED power supply

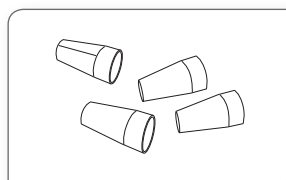

Connection Terminals

Installation steps

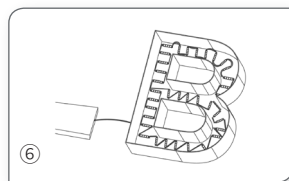
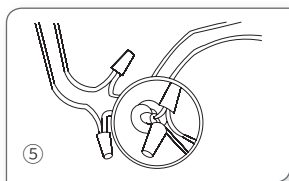
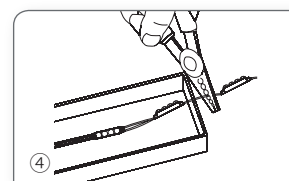
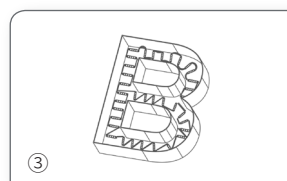
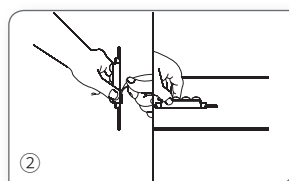
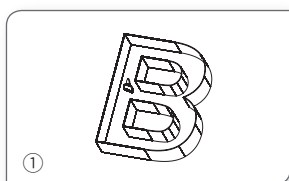



-
1. Clean the mounting surface.
 2. Peel away the release paper on the back of led modules and stick them onto mounting surface.
 3. Evenly arrange the led modules with appropriate space.
 4. Cut the modules according to the requirements and treat the cut place with insulation and waterproof arrangement.
Note: Cut in the middle of the wire.
 5. If the product needs to be connected, it is better to fix with connection ends.
Note: Treat the thread with insulation, waterproof, and anti-corrosion arrangement as it cannot pull out by hands.
 6. Make sure the correct connection of positive and negative poles between led module and power supply.
Note: Treat the thread with insulation, waterproof, and anti-corrosion arrangement as it cannot pull out by hands.
-



Attentions before installation

Before installation, check that the product parameters are consistent with the requirements (Seeing product specifications or product labels) Load voltage, current, power and power supply should be matched with the product.

Follow the instructions of wiring diagram (first connect the load and then the power supply) to avoid short circuit.

Make sure the correct connection of positive and negative poles between products and power supply. Otherwise, the light will not be on.

Make sure the power cord firmly screwed into the terminal and it should not be pulled out by hands.

The terminal should have insulation,waterproof and anti-corrosive treatment.

If the working length exceeded the max run length, make sure to have extra power supply.

If it needs higher current of a LED, make sure having extra cooling.

Common Faults and Troubleshoot

Quick Guide		
Problems	Reasons	Solutions
All LEDs can not light on.	No electric supply.	Power on
	Automatic power protection from the open or short circuit in output of the power supply.	Fix the short circuit problem.
	Wrong connection of power supply.	
LEDs can not light on partly.	Some switching mode power supplies are not powered.	Check the power supply system to fix it.
	Power supply line error.	
	Mistaken wire connection of some of products	Correctly connection
Brightness of LED is inconsistent tor insufficient.	Power overloaded.	Replace with more powerful power
	Power supply circuit excessive consumption.	Make sure the working voltage of the product within $\pm 5\%$ of standard voltage, or keep balance by circuit power consumption.
	Excessive quantities in series connection of the product	Reduce the quantities of the product in series connection to meet requirement.
LED flicker.	Connection point fault.	Remove bad connection point.
	Switching power supply failure.	Replace a new power supply.
	Wrong Installation or use of products	Please follow the instructions

Warning

- Do not disassemble or retrofit the light. Do not touch the surface of the light with a sharp object.
- Do not do live-line working during installation,especially for high voltage product.
- Do not use any organic chemical solvents.
- Use neutral glass adhesive to fix this product and it needs to be dried 4 hours in the open environment after operation.
- Treat the ends and the circuit connection points that are not connected to the main line with insulation,waterproof, and anti-corrosion in the installation.
- Use 18AWG (0.75mm² cross-sectional area) or thicker core wire to avoid adverse consequences caused by overheating, if the power cable need to lengthen.
- Make sure the input voltage meets the requirements and lines are connected correctly before lighting on.
- This product is for signage, and do not use as general lighting.
- Series connection within the max run.
- The length of the power cable between the power supply and the led strip should not exceed 2 meters.Otherwise, large circuit loss will lead to inconsistent brightness.
- Installation, maintenance and repair should be operated by a qualified technician.

Statements and Recycling

Statements:

Repair should be operated by a qualified technician, if the external circuit or main line of this product is damaged.

The parameters given in this manual are typical values and for reference only.

All illustrations and drawings in this manual are for reference.

This product is subject to change without notice.

Recycling:

LED lighting products belongs to electronic products, please do recycling treatment according to the relevant WEEE directives.